

241A PUSHBUTTON OSCILLATOR

OPERATING AND SERVICE MANUAL



HEWLETT  PACKARD



CERTIFICATION

The Hewlett-Packard Company certifies that this instrument was thoroughly tested and inspected and found to meet its published specifications when it was shipped from the factory. The Hewlett-Packard Company further certifies that its calibration measurements are traceable to the U.S. National Bureau of Standards to the extent allowed by the Bureau's calibration facility.

WARRANTY AND ASSISTANCE

All Hewlett-Packard products are warranted against defects in materials and workmanship. This warranty applies for one year from the date of delivery, or, in the case of certain major components listed in the operating manual, for the specified period. We will repair or replace products which prove to be defective during the warranty period. No other warranty is expressed or implied. We are not liable for consequential damages.

For any assistance contact your nearest Hewlett-Packard Sales and Service Office. Addresses are provided at the back of this manual.



OPERATING AND SERVICE MANUAL

(HP PART NO. 241A-904)

**MODEL 241A
PUSHBUTTON OSCILLATOR**

SERIALS PREFIXED: 324-

Appendix C, Manual Backdating
Changes adapts this manual to
Serials Prefixed:

303-00100 and below

Copyright Hewlett-Packard Company 1964
P.O. Box 301, Loveland, Colorado, 80537 U.S.A.

SECTION I GENERAL INFORMATION

SECTION II INSTALLATION

SECTION III OPERATING INFORMATION

SECTION IV PRINCIPLES OF OPERATION

SECTION V MAINTENANCE

SECTION VI REPLACEABLE PARTS

TABLE OF CONTENTS

Section	Page
I GENERAL INFORMATION	1-1
1-1. Description	1-1
1-3. Accessories Available.	1-1
1-5. Instrument Identification	1-1

Section	Page
II INSTALLATION	2-1
2-1. Incoming Inspection	2-1
2-4. Power Requirements	2-1
2-6. Power Cable	2-1
2-8. 230 V Operation	2-1
2-10. Rack Mounting	2-1
2-14. Repackaging for Shipment	2-1

Section	Page
III OPERATING INFORMATION	3-1
3-1. Introduction	3-1
3-3. Front Panel Description.	3-1
3-5. Operating Instructions.	3-1
3-7. Floating Output	3-1
3-9. Balanced Output	3-1
3-11. Primary Power Switching.	3-1

Section	Page
IV PRINCIPLES OF OPERATION.	4-1
4-1. Introduction	4-1
4-4. Oscillator Circuit	4-1
4-7. Frequency Selection.	4-1
4-10. Operation	4-1
4-14. Peak Detector	4-2
4-18. Amplitude Control.	4-2
4-20. Power Supply	4-3

Section	Page
V MAINTENANCE.	5-1
5-1. Introduction.	5-1
5-3. Test Equipment Required	5-1
5-5. Performance Checks.	5-1
5-8. Frequency Check.	5-2
5-9. Frequency Response and Output Voltage Check.	5-2
5-10. Residual Noise Test	5-3
5-11. Output Impedance Check	5-3
5-12. Distortion Check.	5-3
5-13. Top and Bottom Cover Removal	5-3
5-15. Calibration Procedure	5-3
5-18. Power Supply.	5-5
5-19. Frequency Calibration.	5-5
5-21. x1 KC Range	5-5
5-22. x100 CPS Range	5-6
5-23. x10 CPS Range	5-6
5-24. x100 KC Range	5-6
5-25. x10 KC Range.	5-7
5-26. Distortion Adjustment	5-7
5-27. Frequency Selector Switch Assembly Replacement.	5-7
5-29. Servicing Etched Circuit Boards.	5-7
5-32. Troubleshooting	5-8

Section	Page
VI REPLACEABLE PARTS	6-1
6-1. Introduction.	6-1
6-4. Ordering Information.	6-1
6-6. Non-Listed Parts	6-1

Appendix

A	CODE LIST OF MANUFACTURERS
B	SALES AND SERVICE OFFICES
C	MANUAL BACKDATING CHANGES

LIST OF TABLES

Number	Page	Number	Page
1-1. Specifications	1-0	5-4. Frequency Calibration	5-5
1-2. Accessories Available.	1-1	5-5. Using Oscilloscope to Troubleshoot Oscillator	5-8
5-1. Required Test Equipment	5-1	5-6. Troubleshooting Summary	5-10
5-2. Frequency Check.	5-2	6-1. Reference Designation Index	6-2
5-3. Frequency Response.	5-2	6-2. Replaceable Parts	6-8

LIST OF ILLUSTRATIONS

Number	Page	Number	Page
1-1. 241A Oscillator	1-0	4-4. R and C Values of the Pushbutton Selector	4-2
2-1. The Combining Case.	2-0	5-1. Frequency Check Setup.	5-2
2-2. Steps to Place Instrument in Combining Case.	2-0	5-2. Distortion Check Setup	5-3
2-3. Adapter Frame Instrument Combina- tion	2-1	5-3. Cover Removal	5-4
3-1. Front Panel Description.	3-0	5-4. Rear View.	5-4
3-2. Balanced Line Configuration using 11004A	3-1	5-5. Amplifier Board Assembly.	5-5
3-3. Balanced Line Configuration using 11005A	3-1	5-6. Top View	5-6
3-4. Operating Instructions.	3-2	5-7. Range Capacitor Board Assembly	5-6
4-1. Block Diagram.	4-0	5-8. Typical Waveforms	5-9
4-2. Simplified Partial Schematic Diagram	4-0	5-9. Bottom View.	5-10
4-3. Ratio Graph for the Wien Bridge Oscillator.	4-2	5-10. Amplifier and Power Source	5-11/5-12
		5-11. Multiplier Switch	5-13/5-14
		5-12. Frequency Selector Switch	5-15/5-16

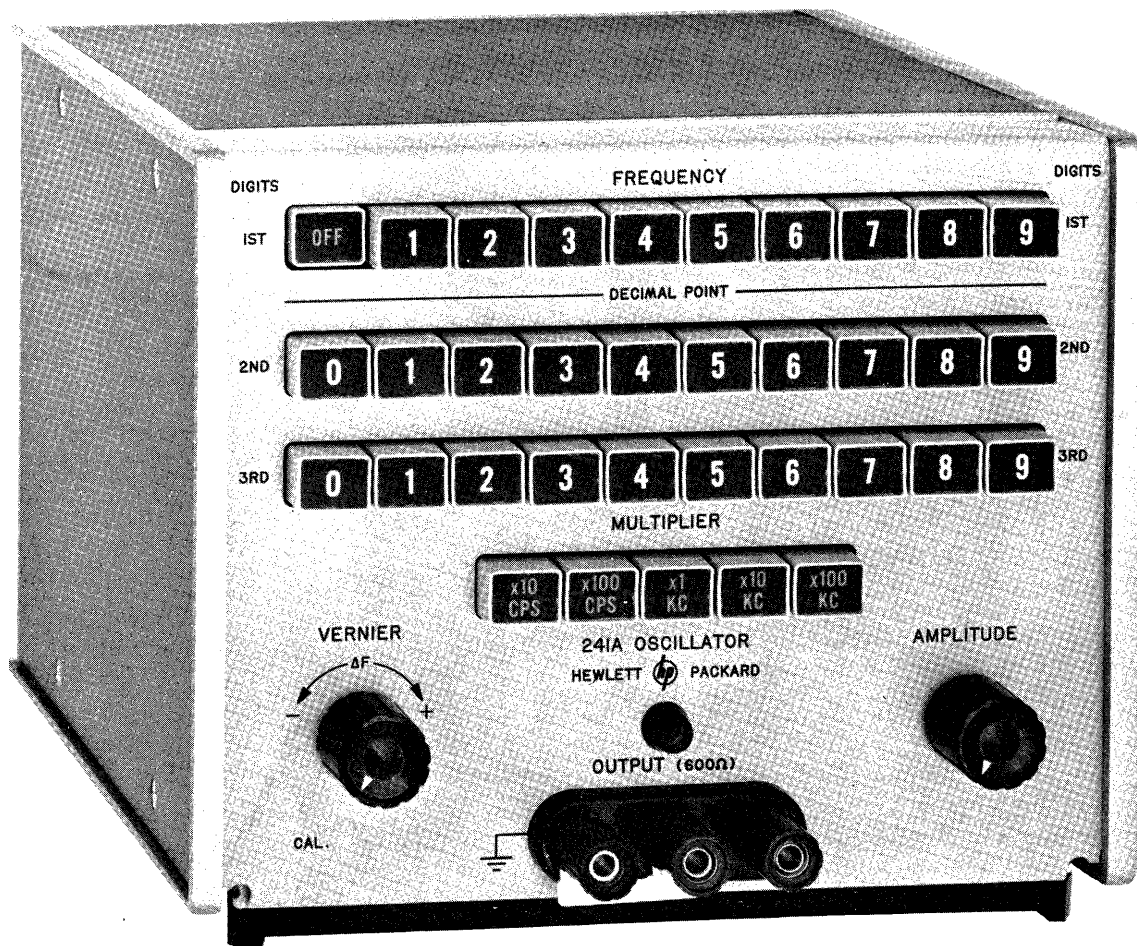







Figure 1-1. The  Model 241A Oscillator

Table 1-1. Specifications

<p>FREQUENCY: 10 cps to 1 Mc, 5 ranges, 4500 frequency increments with vernier overlap.</p> <p>CALIBRATION ACCURACY: $\pm 1\%$</p> <p>FREQUENCY RESPONSE: $\pm 2\%$ into rated load.</p> <p>OUTPUT IMPEDANCE: 600 ohms</p> <p>DISTORTION: 1%</p> <p>HUM AND NOISE: 0.05% of output</p> <p>OUTPUT: +10 to -30 DBM into 600 ohms (2.5 volts RMS max.).</p>	<p>POWER: 115 or 230 volts, 50 to 1000 cps, 1 watt.</p> <p>DIMENSIONS: 7-25/32 in. wide, 6-1/2 in. high, 8 in. deep. (19.8 cm x 16.5 cm x 20.3 cm)</p> <p>WEIGHT: Net 7 3/4 lbs. (3.5 kg)</p> <p>EQUIPMENT FURNISHED: Detachable power cord, NEMA plug.</p> <p>EQUIPMENT AVAILABLE:  11000A Cable, 44" long, dual banana plugs.  11002A Test Leads, 60" long, dual banana plug to alligator clips.  11004A Line Matching Transformer.  11005A Bridging Transformer.</p>
--	---

SECTION I GENERAL INFORMATION

1-1. DESCRIPTION.

1-2. The Hewlett - Packard Model 241A Pushbutton Oscillator provides a continuously variable voltage output from -30 DBM to +10 DBM at frequencies from 10 cps to 999 kc. Pushbutton tuning enables frequency to be changed at precise increments. Four thousand five hundred explicit frequencies are available. An overlapping VERNIER control permits the setting of intermediate frequencies and extension of 999 kc range to over 1 Mc. Because of the pushbutton feature, Model 241A frequency selection and resettability are better than 0.02%. The Model 241A Pushbutton Oscillator is shown in Figure 1-1; specifications are given in Table 1-1.

1-3. ACCESSORIES AVAILABLE.

1-4. Table 1-2 lists accessories which are made by Hewlett-Packard to increase the usefulness of your oscillator. Accessory specifications and uses are given in the table.

1-5. INSTRUMENT IDENTIFICATION.

1-6. Hewlett-Packard uses a two-section eight-digit serial number (000-00000). If the first three digits of the serial number on your instrument do not agree with those on the title page of this manual, change sheets supplied with the manual will define differences between your instrument and the Model 241A described in this manual.

Table 1-2. Accessories Available

Model No.	Use	Features
11004A	Line Matching Transformer Provides balanced 135 or 600 ohm input to 600 ohm unbalanced output for measurements on balanced lines.	Terminating Resistance: 600 or 10 K ohms Frequency Range: 5 to 600 kc Power Handling Capacity: ±22 DBM (10 V into 600 ohms) Balance: Better than 40 db entire frequency range.
11005A	Line Bridging Transformer Provides balanced 600 ohm input to unbalanced 600 ohm output for measurements on balanced lines.	Terminating Resistance: 600 or 10 K ohms Frequency Range: 20 cps to 45 kc Power Handling Capacity: -15 DBM (4.5 V into 600 ohms)
11000A 11002A	Test Leads	Dual Banana Plug Banana Plug to Alligator Clips

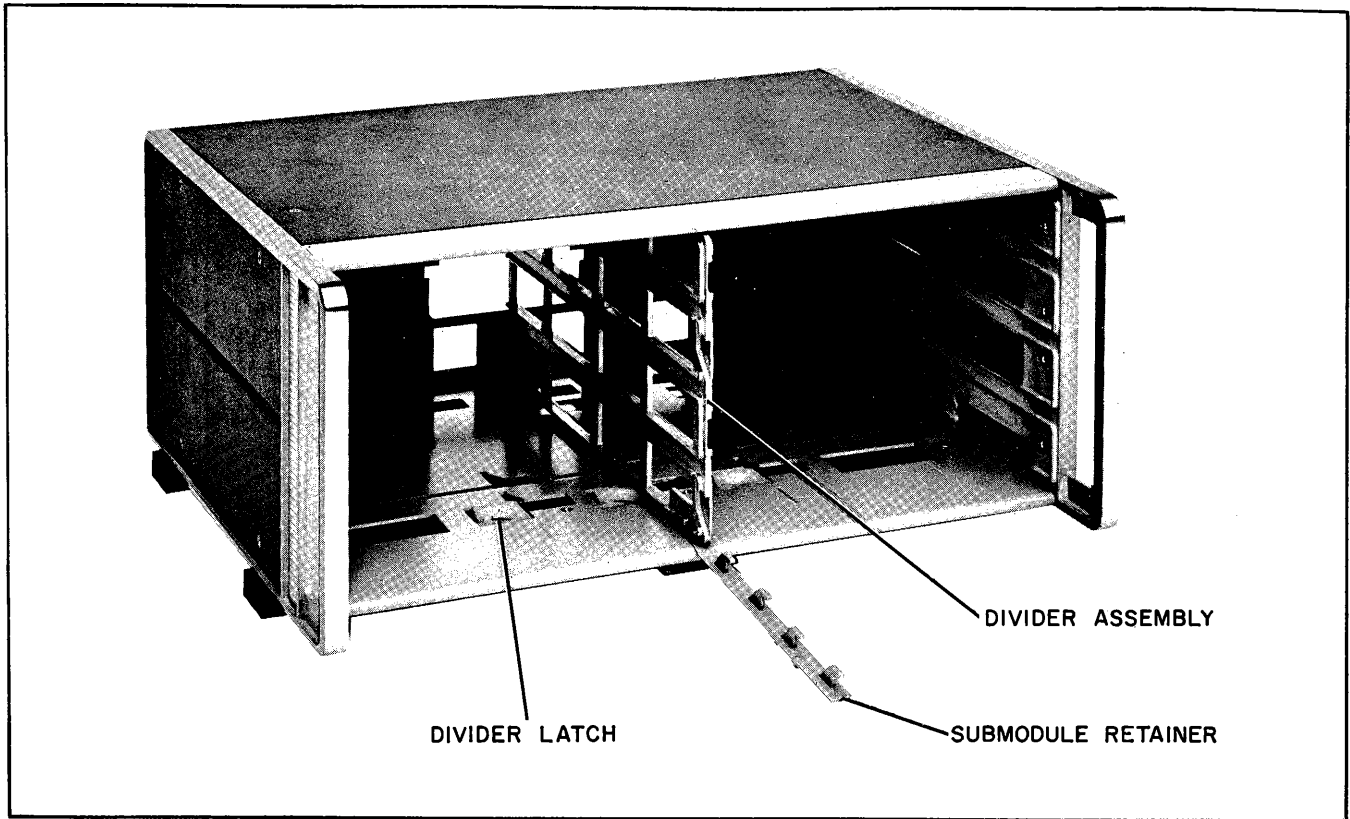

Figure 2-1. The Combining Case

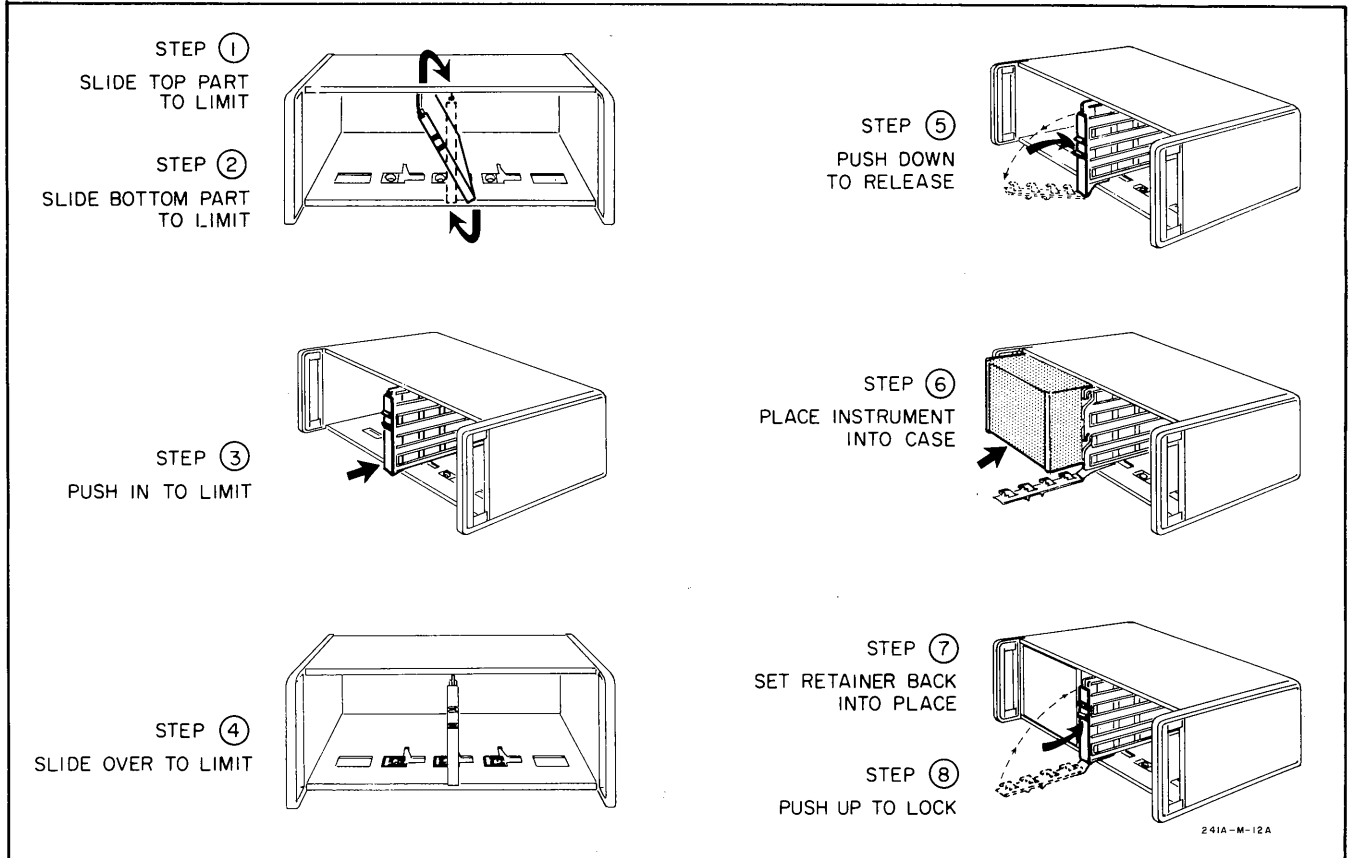

Figure 2-2. Steps to Place Instrument in Combining Case

SECTION II INSTALLATION

2-1. INCOMING INSPECTION.

2-2. Unpack the instrument upon receipt and inspect it for signs of physical damage such as scratched panel knobs, etc. If there is any apparent damage, file a claim with the carrier and refer to the warranty page on inside front cover of this manual.

2-3. An electrical inspection should be performed as soon as possible after receipt. Use the performance checks, Paragraph 5-5 to check the instrument against its specifications.

2-4. POWER REQUIREMENTS.

2-5. The Model 241A requires a power source of 115/230 volts $\pm 10\%$, 50 to 1000 cps, approximately 1 watt.

2-6. POWER CABLE.

2-7. This Hewlett-Packard instrument is equipped with a three-conductor power cable terminated in a polarized, three-prong male connector recommended by the National Electrical Manufacturer's Association (NEMA).

WARNING

The third conductor grounds the instrument chassis for the PROTECTION OF OPERATING PERSONNEL. When using a three-prong adapter, ground third lead (green wire) externally.

2-8. 230 V OPERATION.

2-9. This instrument may be used with either a 115 volt or 230 volt, 50 to 1000 cps. A switch located at the rear of the instrument enables the operator to select either 115 or 230 volt position.

2-10. RACK MOUNTING.

2-11. The Model 241A is a submodular unit, which, when used alone, can be bench mounted only. However, when used in combination with other submodular units, it can be bench and/or rack mounted. The combining case and adapter frame are designed specifically for this purpose.

2-12. COMBINING CASE. The combining case is a full-module unit which accepts varying combinations of submodular units. Being a full-module unit, it can be bench or rack mounted analogous to any full-module instrument. An illustration of the combining case is shown in Figure 2-1. Instructions for installing the Model 241A in a combining case are given graphically in Figure 2-2.

2-13. ADAPTER FRAME. The adapter frame is a rack frame that accepts any combination of submodular units. It can be rack mounted only. An illustration of the adapter frame is given in Figure 2-3.

2-14. REPACKAGING FOR SHIPMENT.

2-15. The Model 241A is shipped in a foam-pack and cardboard carton. When repackaging the instrument for shipment, the original foam-pack and cardboard carton can be used if available. If not available, they can be purchased from Hewlett-Packard Co. (refer to Section VI, misc.). Use the following as a general guide for repackaging the instrument.

- a. Place the instrument in the foam-pack.
- b. Mark the packing box with "Fragile," "Delicate Instrument," etc. as appropriate.

2-16. When returning an instrument to the Hewlett-Packard Company for service or repair, attach a tag to the instrument specifying the owner and desired action. All correspondence should identify the instrument by model number and full serial number.

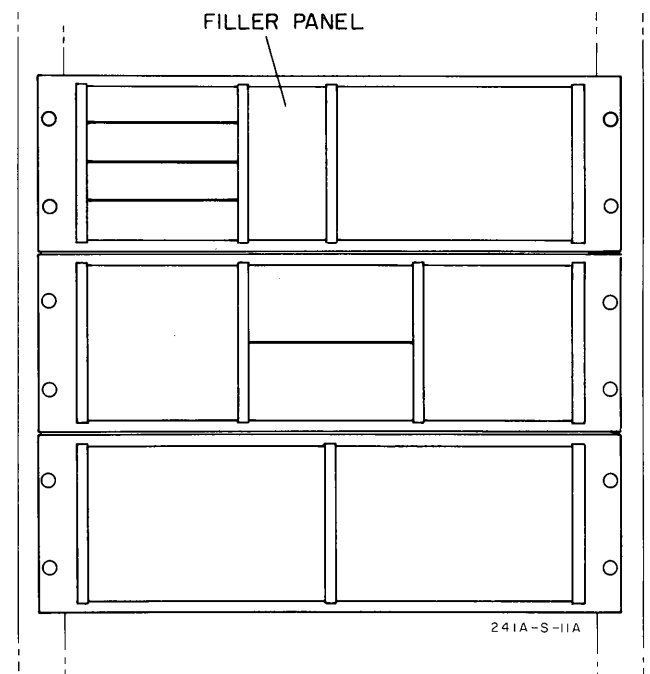
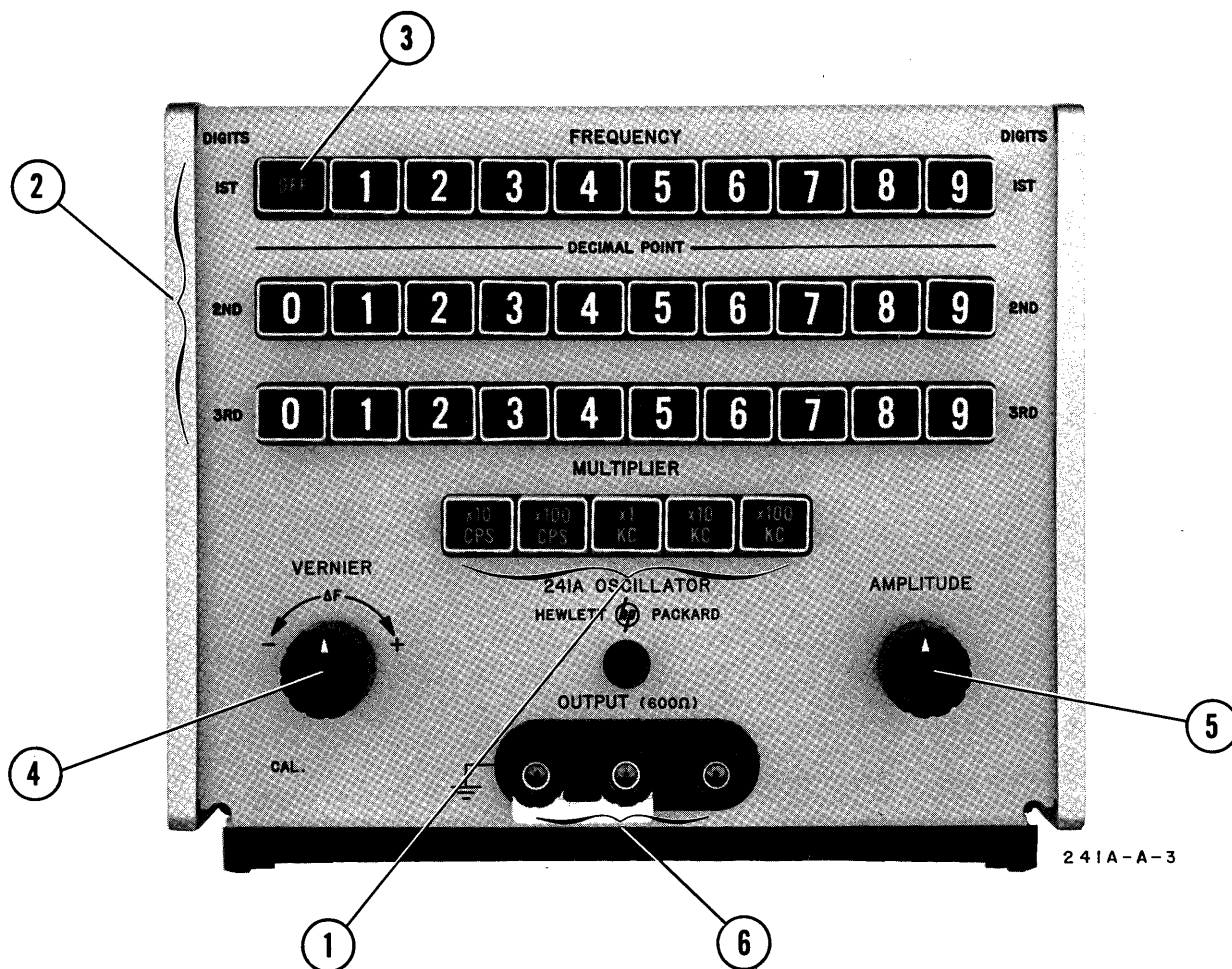

Figure 2-3. Adapter Frame Instrument Combination



1. The MULTIPLIER pushbuttons select frequency range.
2. Pushbutton switches permit selection of 4500 frequencies. Frequencies from 10 cps to 999 kc can be selected by depressing the appropriate FREQUENCY and MULTIPLIER pushbuttons. The top row (1st) selects the first digit, middle row (2nd) selects the second digit, and bottom row (3rd) selects the third digit. Depression of any number in the 1st-DIGIT row turns the instrument on; the lamp above the OUTPUT terminals glows.
3. The OFF pushbutton, when depressed, turns the instrument OFF.
4. The VERNIER provides selection of frequencies between pushbutton settings and extends the Model 241A 999 kc range to over 1 Mc. When VERNIER is in CAL. position, output frequency is selected by pushbuttons only.
5. The AMPLITUDE control provides a continuously variable output from -30 to +10 DBM.
6. The OUTPUT terminals provide a constant 600-ohm impedance. The output can be floating or referenced to chassis ground.

Figure 3-1. Front Panel Description

SECTION III OPERATING INFORMATION

3-1. INTRODUCTION.

3-2. The Model 241A Pushbutton Oscillator provides pushbutton tuned frequencies from 10 cps to 999 kc with an accuracy of 1%. An overlapping vernier control permits setting of intermediate frequencies and extension of the 999 kc range is over 1 Mc. Frequency selection and resettability is better than 0.02%.

3-3. FRONT PANEL DESCRIPTION.

3-4. The front panel controls are explained in Figure 3-1. Explanations are keyed to a photo of the instrument front panel that accompanies the figure.

3-5. OPERATING INSTRUCTIONS.

3-6. Operating instructions are given in Figure 3-4. Supplemental information about operation of Model 241A is given below.

3-7. FLOATING OUTPUT.

3-8. The Model 241A will provide floating outputs or outputs referenced to ground. Disconnecting ground strap on the front-panel OUTPUT terminals provides a floating output.

3-9. BALANCED OUTPUT.

3-10. The Model 241A will provide a fully-balanced output when used in conjunction with the Model 11004A or 11005A Transformers. Figure 3-2 shows a balanced line configuration using the Model 11004A in the 5 kc to 600 kc range. Figure 3-3 shows a balanced line configuration using the 11005A in the 20 cps to 45 kc range.

3-11. PRIMARY POWER SWITCHING.

3-12. Depression of the OFF pushbutton removes power from the instrument; depression of any digit on the 1st-DIGITS row applies power to the instrument; the lamp glows. If neither the OFF pushbutton nor a 1st-row DIGITS pushbutton is depressed, power is applied to the instrument; but no output will be available at the OUTPUT terminals.

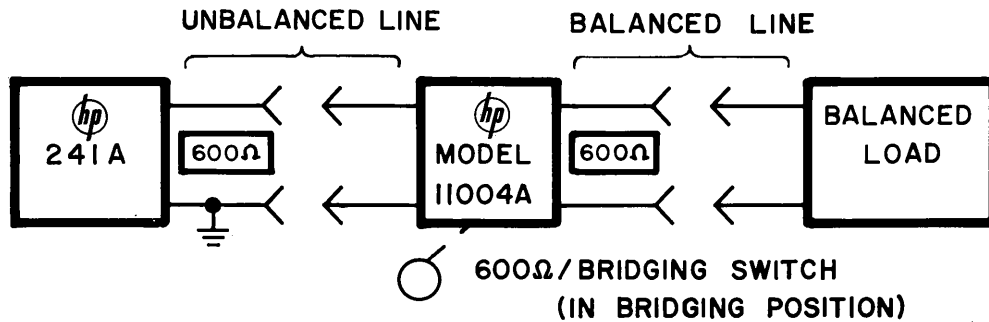

Figure 3-2. Balanced line configuration using 11004A

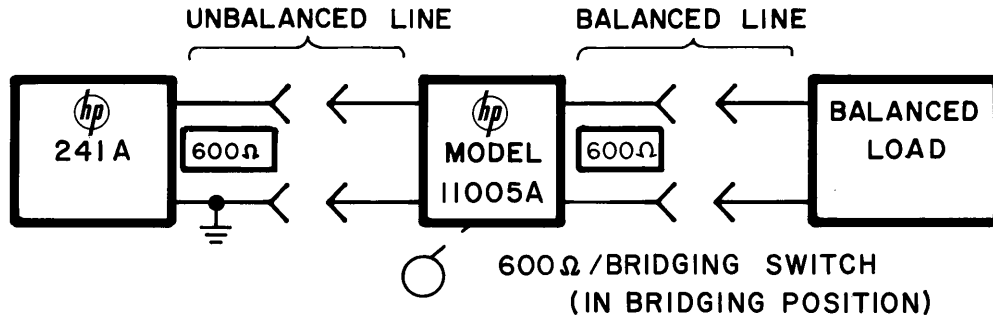
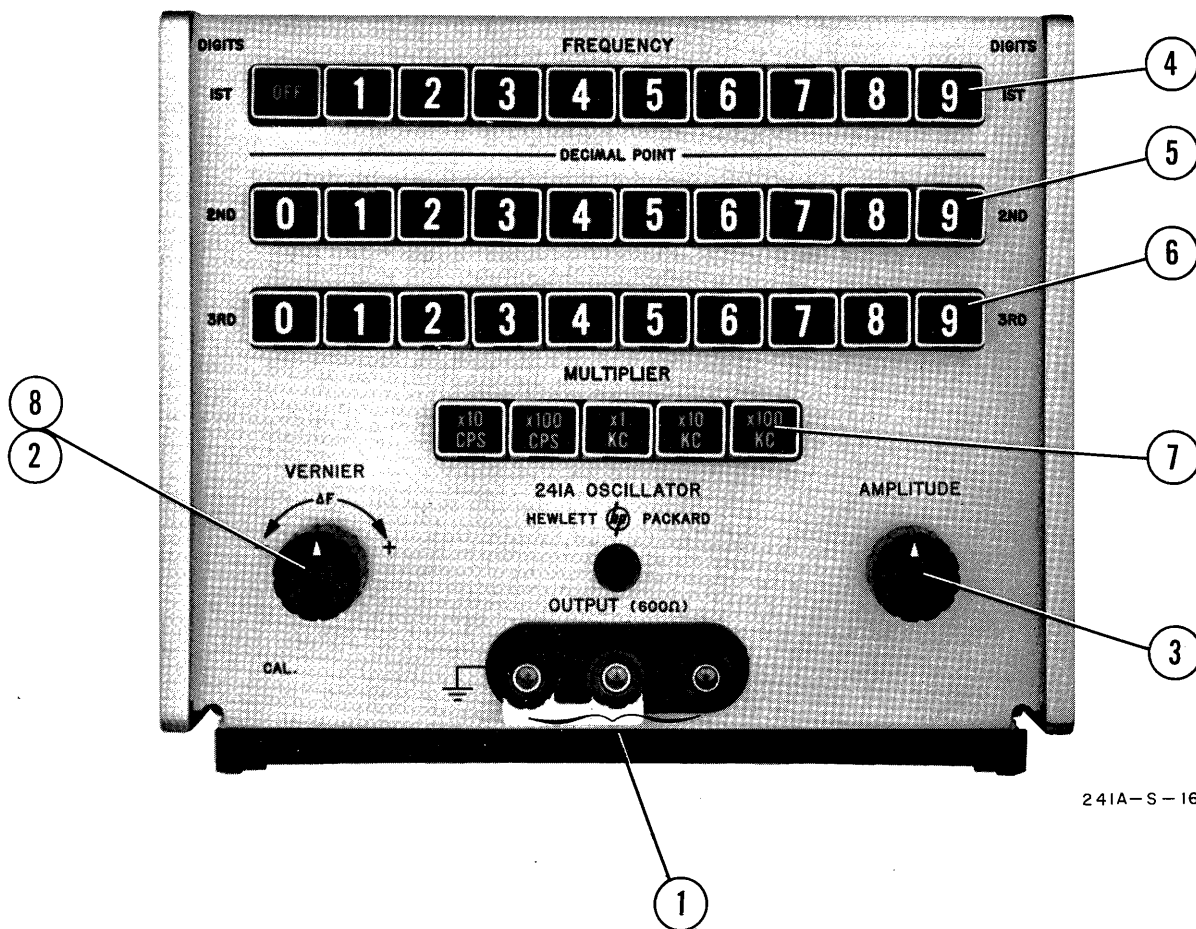

Figure 3-3. Balanced line configuration using 11005A



241A-S-16A

1. Connect the Model 241A in setup; the OUTPUT can be floated or tied to chassis ground, using the shorting bar provided with instrument.
2. Set VERNIER fully counterclockwise to CAL. position.
3. Set the AMPLITUDE control for the desired output level. The AMPLITUDE control has a range of -30 DBM to +10 DBM when rotated from the maximum counterclockwise to the maximum clockwise position.
4. Depress desired pushbutton in the 1st row to obtain first digit; the OFF button will release; the lamp glows, and power is applied to the instrument.
5. Depress desired pushbutton in the 2nd row to obtain second digit.

NOTE

There is a decimal point between the first and second digit.

6. Depress desired pushbutton in the 3rd row to obtain third digit.
7. Depress MULTIPLIER button for desired range.

NOTE

If the 1, 5, 7 pushbutton and x10 CPS MULTIPLIER pushbutton were depressed, output frequency would be $1.57 \times 10 = 15.7$ cps.

8. If extension of the 999 kc range is desired or selection of frequencies between ranges, rotate the VERNIER control clockwise to desired setting.

Figure 3-4. Operating Instructions

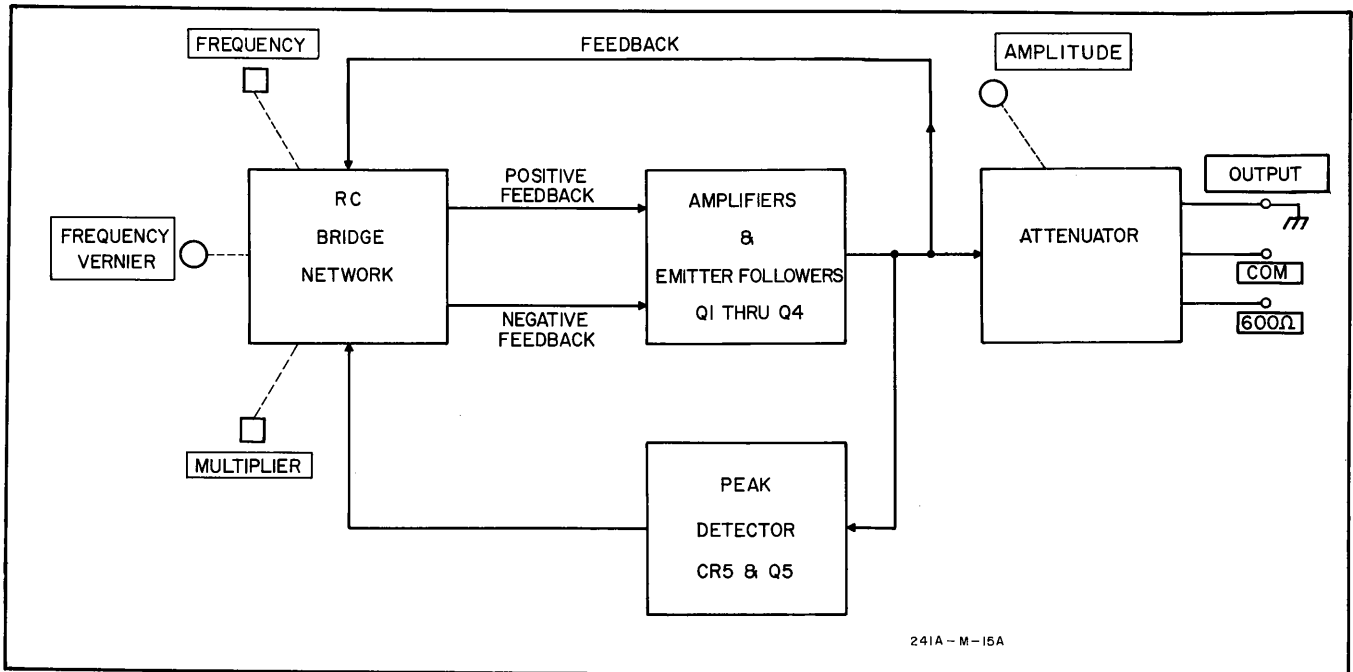

Figure 4-1. Block Diagram

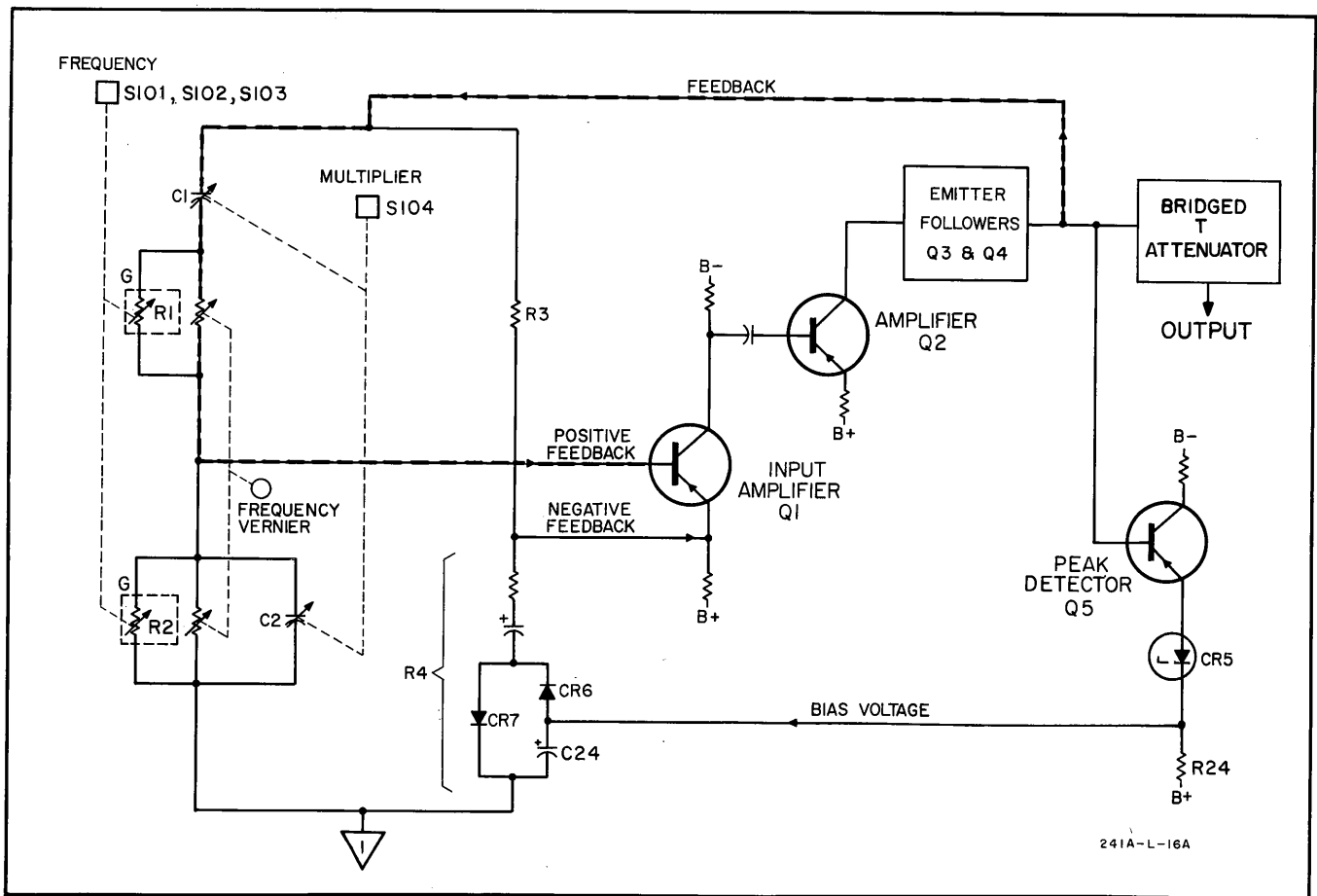

Figure 4-2. Simplified Partial Schematic Diagram

SECTION IV

PRINCIPLES OF OPERATION

4-1. INTRODUCTION.

4-2. The Model 241A consists of a Wein bridge oscillator circuit, a peak detector circuit, and an output attenuator. These circuits and the front panel controls associated with them are shown in the block diagram, Figure 4-1.

4-3. Referring to Figure 4-1, the oscillator consists of a Wein bridge, a two-stage amplifier, and a complementary symmetry circuit. The Wein bridge consists of an RC frequency selective network and a resistive voltage divider network. The RC frequency selective network supplies positive feedback to the amplifier which maintains the output at a constant frequency. The peak detector in conjunction with the divider network maintains a constant amplitude. The AMPLITUDE control is a bridged-T attenuator which provides levels of -30 DBM to +10 DBM at a constant output impedance of 600 ohms. The attenuator, capacitively decoupled from the amplitude circuit eliminates the need for a DC balance adjustment at the output.

4-4. OSCILLATOR CIRCUIT.

4-5. The Wein bridge in the oscillator circuit consists of an RC frequency selective network and a resistive voltage divider network. Referring to Figure 4-2 (Simplified Schematic Diagram), the frequency selective network, together with the resistive divider leg, is a Wein Bridge.

4-6. Oscillations are maintained by applying a positive feedback signal from the oscillator output circuit back to the Wein bridge network. The proper phase relationship at the desired frequency is maintained by the RC components in the bridge. The multiplier frequency tuning elements are fixed capacitors. digits tuning elements are resistors. Tuning capacitors and resistors are switched in by S101 through S104.

4-7. FREQUENCY SELECTION.

4-8. The frequency of oscillation is determined by the RC FREQUENCY Selective Network. When the resistance and capacitance in the parallel RC arm of the Wein bridge are equal to the resistance and capacitance in the series RC arm, the frequency of oscillation is determined by the relation:

$$f = \frac{G}{2\pi C_1}$$

where: G = conductance (reciprocal of resistance)
C = capacitance in each arm

The conductances are varied over a 10:1 range by three sets of pushbuttons, while a fourth set selects one of five decade ranges by changing the C's as shown in Figure 4-2.

4-9. To achieve pushbutton selection with three significant digits, each conductance is composed of a parallel combination of three conductances G1, G2, G3 (see Figure 4-4). Using these values, the frequency determining equations may be written as:

$$f = \frac{(G1, +G2, +G3)}{2\pi C}$$

The units digit switch selects G1 from nine multiples of a basic conductance G_0 . The second digit switch selects G2 as one of ten multiples of a basic conductance $0.1 G_0$, and the hundredths digit selects G3 as one of ten multiples of a basic conductance $0.01 G_0$. Since G_0 appears as a factor in all three conductances, the frequency expression can be written as:

$$f = \frac{(A + 0.1 B + 0.01 C) G_0}{2\pi C}$$

where: A = any digit from 1 to 9
B and C = digits from 0 to 9

Thus the top row of pushbutton switches selects the first significant digit (G1) of the numerical value of the output frequency; the second row selects the second significant digit (G2), and the third row selects the third significant digit (G3). The multiplier switch selects one of five pairs of capacitors as decade range multipliers from x100 CPS to x100 KC. (See Figure 4-4.) The vernier control changes the value of G1 to provide continuous frequency coverage.

4-10. OPERATION.

4-11. The frequency-selective network consists of a series RC branch and a parallel RC branch. The series branch is represented by C1 and R1 in Figure 4-2; the parallel branch is represented by C2 and R2. For the frequency at which $X_C = R$ in the RC network, the feedback signal at the base of the input amplifier Q1 (oscillator) is of the right phase and of sufficient amplitude to sustain oscillation; at frequencies where X_C does not equal R, phase and amplitude of the feedback signal are such that oscillation cannot be maintained. Figure 4-3 shows ratio and phase relationship of the positive feedback voltage to oscillator circuit output voltage for frequencies above, at, and below the frequency where $X_C = R$. For example, if the frequency should shift, the magnitude of the positive feedback signal will decrease and will no longer be greater than the negative feedback across the resistor divider. At this time, the input to the amplifier will approach zero, and oscillations above or below resonance will cease.

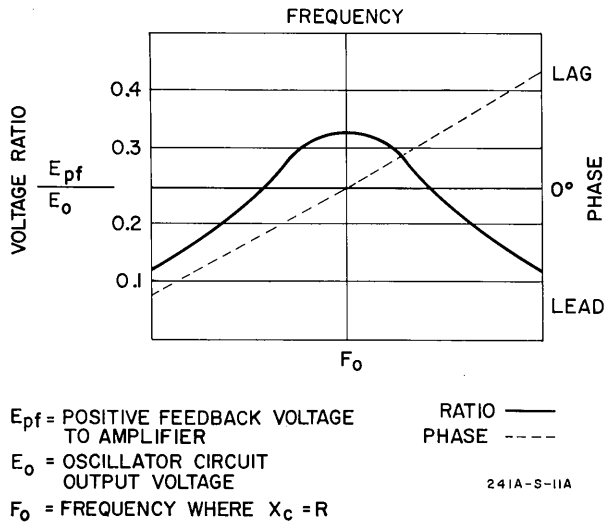

Figure 4-3. Ratio Graph for the Wien Bridge Oscillator

4-12. The resistive voltage-divider network is represented by R3 and R4 in Figure 4-2. The signal developed across R4 is the negative feedback, and the magnitude of this signal is due in part to the dynamic resistance of CR6 and CR7. This dynamic resistance is controlled by the amount of forward bias applied to the diodes from the peak detector circuit. If the oscillator circuit output voltage changes, the peak detector circuit converts the change to bias the diodes at a different level. Since the resistance of a diode varies inversely with conduction through it, changing the bias varies diode resistance and therefore changes the voltage-division ratio of the resistive divider, varying the amount of negative feedback. For example, if the oscillator circuit output voltage were to increase the peak detector circuit would decrease (refer to Paragraph 4-16) the forward bias on CR6 and CR7, increasing diode dynamic resistance. Increased resistance of R4 increases the amount of negative feedback to the emitter of input amplifier Q1, decreasing the net input to the amplifier, and thus decreasing the oscillator output signal so as to maintain the output at a constant level.

4-13. Amplifiers Q1 and Q2 amplify the signal and apply it to complementary emitter followers Q3 and Q4 (Figure 5-10). The emitter followers are forward-biased by CR2 and CR3; and, under a no-signal condition, the emitter followers are conducting slightly to minimize crossover distortion. The oscillator output is sampled by peak detector Q5 and is connected to the attenuator in the output circuit.

4-14. PEAK DETECTOR.

4-15. The peak detector circuit, which includes Q5 and CR5, samples the oscillator circuit output voltage, and supplies bias to the diodes in the resistive voltage-divider network. The bias voltage, which is inversely proportional to the output signal, controls the dynamic resistance of the diodes.

4-16. The emitter of transistor Q5 follows the output signal. At -7 volts, diode CR5 breaks down, and the voltage at the junction of CR5 and C24 (Figure 4-2) decreases. This changes the bias to CR6 and CR7, which affects the resistance of these diodes. Capacitor C24 averages the bias voltage applied to the diodes over the period of one cycle.

4-17. Referring to Figure 5-10, the peak detector is AC coupled through capacitor C12 which allows the peak detector operation to remain independent of power supply voltage fluctuates. Resistor R18 is used for a DC return, and R15 is used to bias transistor Q5. Diode CR4 protects transistor Q5 emitter base junction from the 7-volt reverse bias.

4-18. AMPLITUDE CONTROL.

4-19. The output of the oscillator is fed to the attenuator (amplitude control). This bridged-T type attenuator is variable over a 40 db range by the AMPLITUDE front panel control. The signal at this point travels to the OUTPUT terminals.

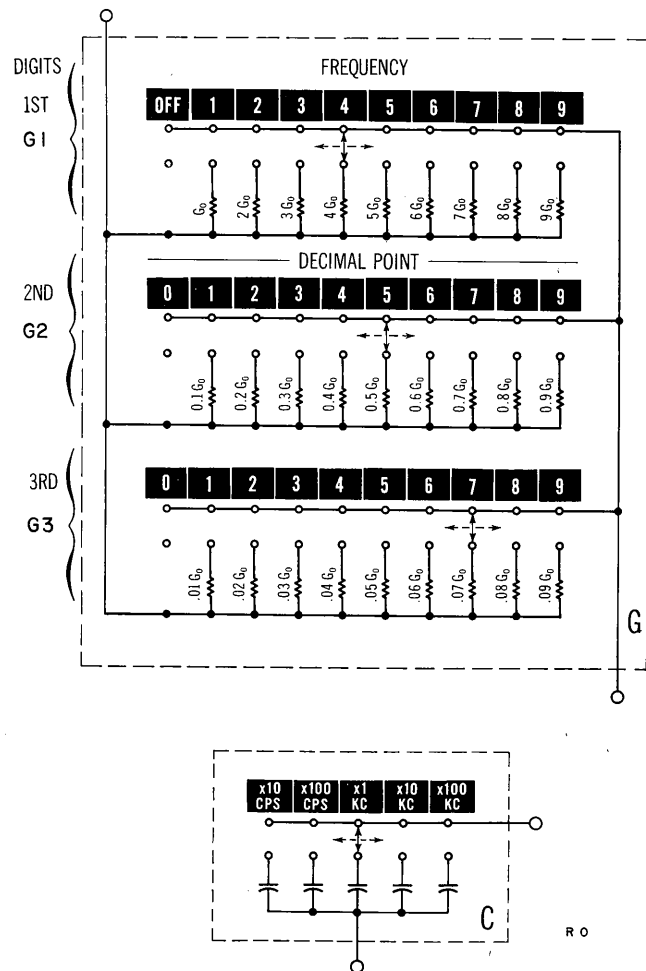

Figure 4-4. R and C Values of the Pushbutton Selector

4-20. POWER SUPPLY.

4-21. Figure 5-10 illustrates a conventional power supply in the lower right corner of the schematic. For 115-volt operation, the power transformer is switched directly to the AC line via switch S101A. A 10 K resistor is switched in series with the AC line

for 230-volt operation. The rectifier circuit is a conventional full-wave bridge whose negative leg composes a voltage divider. Output voltage of the +12.5-volt supply is regulated between 11.9 and 13.1 volts DC by breakdown diode CR16. Output voltage of the -14 volt supply is regulated between -13.3 volts and -14.7 volts by breakdown diode CR15

SECTION V MAINTENANCE

5-1. INTRODUCTION.

5-2. This section contains maintenance and service information on the Model 241A Oscillator. A performance check is included in this section which can be used to verify instrument operation. This check can be made with the covers attached to the instrument as a part of routine maintenance or incoming quality control inspection.

5-3. TEST EQUIPMENT REQUIRED.

5-4. The critical specifications and suggested test equipment needed in the performance and calibration procedures are given in Table 5-1.

5-5. PERFORMANCE CHECKS.

5-6. The performance checks are in-cabinet procedures verifying that the Model 241A is operating within specifications. These checks can be used for an incoming inspection test, for periodic maintenance, or to check instrument performance after repairs.

5-7. The performance checks are performed with the AC power cord connected to nominal line voltage (115 V/230 V) 50 to 1000 cps unless otherwise specified.

Table 5-1.

Required Test Equipment

Instrument Type	Required Characteristics	Use	Recommended Model
Oscilloscope	Passband: DC to 1 Mc Sensitivity: 0.05 volts/cm Input Impedance: 1 megohm	Waveform Measurement	Ⓜ Model 175A with plug-in Model 1751A
Distortion Analyzer	Measure distortion to -40 db at 20 kc	Distortion Measurement	Ⓜ Model 330B/C/D
AC Voltmeter	Frequency Range: 10 cps to 1 Mc Voltage Range: 1 mv to 5 V Accuracy: ±1.0% 50 cps to 500 kc ±2.0% 20 cps to 1 Mc ±5.0% 10 cps to 4 Mc	AC Voltage Measurements	Ⓜ Model 400H
DC Voltmeter	Voltage Range: Positive and Negative voltages from 100 mv to 15 volts Input Impedance: at least 10 megohms	DC Voltage Check	Ⓜ Model 412A
Frequency Counter	Counting Range: 10 cps to 1 Mc. 10 period average for time interval of 1 ms Accuracy: 0.1%	Frequency Measurements	Ⓜ Model 5232A / 5532A
Resistor	600 ohms, 1/2 watt ±1%	Maintenance Test	Ⓜ Stock No. 0727-0081
Variable Auto Transformer	Voltage Range: 102-128 vac Meter Accuracy: ±2% Power Capability: 1 W	Power Supply Tests	General Radio W10MT3A
Printed Circuit Board extender	18 pin connector	Troubleshooting	Ⓜ Stock No. 5060-2041

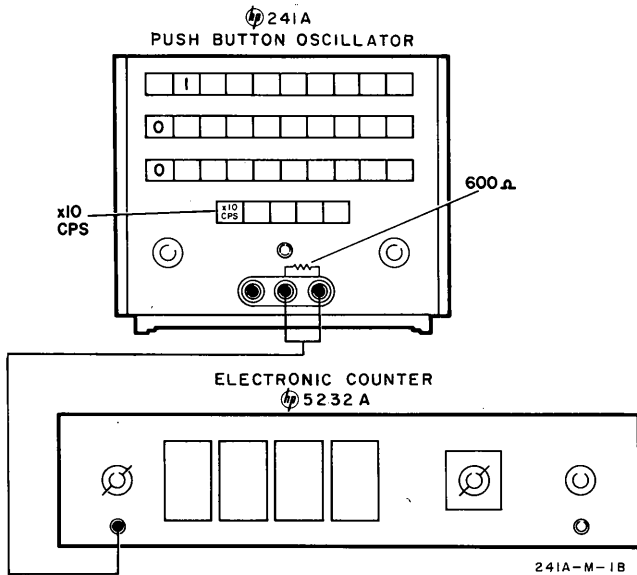

Figure 5-1. Frequency Check Setup

5-8. FREQUENCY CHECK.

- a. Connect Model 241A as shown in Figure 5-1.
- b. Set Model 241A controls as follows: (10 cps) MULTIPLIER. x10 cps
 FREQUENCY Pushbuttons . . . 1.00
 AMPLITUDE MAX.
 VERNIER. CAL.
- c. Set Electronic Counter FUNCTION Switch to measure 10 PERIOD AVERAGE in milliseconds.
- d. The Electronic Counter should read between 99.000 and 101.000 milliseconds (1%).
- e. Set Model 241A FREQUENCY pushbuttons to 5.00 (50 cps); Electronic Counter should read between 19.900 and 20.200 milliseconds.
- f. Set Model 241A FREQUENCY pushbuttons to 9.00 (90 cps); Electronic Counter should read between 11.000 and 11.222 milliseconds.
- g. Depress Model 241A MULTIPLIER pushbuttons to x100 CPS and the FREQUENCY pushbuttons to 1.00 (100 cps).
- h. The Electronic Counter should read between 9.999 and 10.10000 milliseconds.
- j. Set Electronic Counter FUNCTION switch to FREQUENCY.
- k. Depress Model 241A FREQUENCY pushbuttons to 5.00; the Electronic Counter should read 500 cps \pm 5 cps.
- m. Depress Model 241A MULTIPLIER and FREQUENCY pushbuttons as called out in Table 5-2. The Frequency Counter should indicate value given.

Table 5-2. Frequency Check

MULTIPLIER PUSHBUTTON	FREQUENCY PUSHBUTTON	FREQUENCY COUNTER READING
x100	5.00	500 cps \pm 5 cps
x100	9.00	900 cps \pm 9 cps
x1 KC	1.00	1000 cps \pm 10 cps
x1 KC	5.00	5000 cps \pm 50 cps
x1 KC	9.00	9000 cps \pm 90 cps
x10 KC	1.00	10 kc \pm 100 cps
x10 KC	5.00	50 kc \pm 500 cps
x10 KC	9.00	90 kc \pm 900 cps
x100 KC	1.00	100 kc \pm 1 kc
x100 KC	5.00	500 kc \pm 5 kc
x100 KC	9.00	900 kc \pm 9 kc

5-9. FREQUENCY RESPONSE AND OUTPUT VOLTAGE CHECK.

- a. Connect an AC Voltmeter (Model 400H) and a 600-ohm load across Model 241A OUTPUT.

NOTE

Use a split pair one foot long, with banana plugs on each end to connect the 400H to the Model 241A.

- b. Depress Model 241A x1 KC MULTIPLIER and 1.00 DIGITS pushbuttons (1000 cps).
- c. Adjust the 241A AMPLITUDE control for a 2.5 volt rms reading on the AC Voltmeter. For all frequencies in Table 5-3, the AC Voltmeter should read 2.5 \pm 0.05 volts.

NOTE

The \pm 0.05 volt tolerance applies to the Model 241A only; therefore, a calibration curve for the AC Voltmeter should be used when making this measurement.

- d. Rotate Model 241A AMPLITUDE control fully counter-clockwise. The AC Voltmeter should indicate less than 25 millivolts for all frequencies listed in Table 5-3.

Table 5-3. Frequency Response

MULTIPLIER PUSHBUTTON	FREQUENCY PUSHBUTTON
x1 KC	1.00
x1 KC	5.00
x1 KC	9.00
x100 CPS	1.00
x100 CPS	5.00
x100 CPS	9.00
x10 CPS	1.00
x10 CPS	5.00
x10 CPS	9.00
x10 KC	1.00
x10 KC	5.00
x10 KC	9.00
x100 KC	1.00
x100 KC	5.00
x100 KC	9.00

5-10. RESIDUAL NOISE TEST.

- a. Disable the oscillator by depressing a MULTIPLIER button half way and then releasing; all range buttons should then be in the released position.
- b. Connect an AC Voltmeter (Ⓞ Model 400H) and a 600-ohm load across the Model 241A OUTPUT terminals. The residual Noise should not exceed 1.25 mv (0.05% of output).

5-11. OUTPUT IMPEDANCE CHECK.

- a. Connect an AC Voltmeter (Ⓞ Model 400H) across Model 241A terminals.
- b. Set Model 241A controls as follows:
MULTIPLIERx1 KC
FREQUENCY Pushbutton. . . .1.00
VERNIERCAL.
- c. Adjust the AMPLITUDE control to obtain an indication of 5.0 volts on the AC Voltmeter.
- d. Connect a 600 ohm $\pm 1\%$ load across Model 241A OUTPUT terminals.
- e. The AC Voltmeter should indicate 2.5 volts ($\pm 5\%$)

5-12. DISTORTION CHECK.

- a. Connect the Model 241A as shown in Figure 5-2.
- b. Set Model 241A controls as follows:
MULTIPLIERx1 KC
FREQUENCY Pushbuttons . . .1.00
AMPLITUDEMAX.
VERNIERCAL.

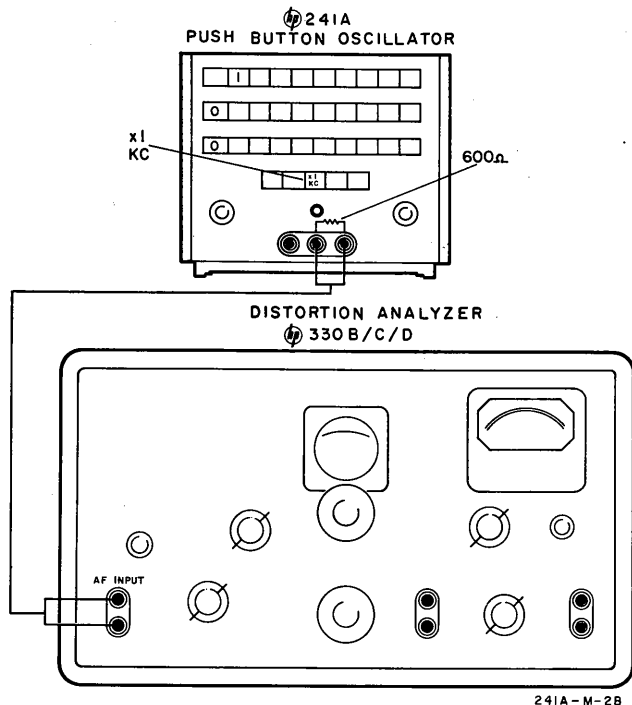

Figure 5-2. Distortion Check Setup

- c. Set Distortion Analyzer controls as follows:
FREQUENCY RANGE.x100
INPUT.AF
FUNCTIONSet Level
METER RANGE.100%
- d. Adjust Distortion Analyzer INPUT SENSITIVITY for full-scale reading (1.0).
- e. Set FUNCTION switch to DISTORTION.
- f. Adjust Distortion Analyzer FINE and COARSE frequency controls and BALANCE control for a dip or null (on Distortion Analyzer meter) at fundamental frequency (1 KC), switch METER RANGE as necessary to obtain upscale meter reading.
- g. Readjust controls until maximum meter dip or null is obtained.
- h. Meter reading should be less than 1.0 on 1% range of Distortion Analyzer.
- j. Repeat Steps d through h at frequencies of 20 cps and 20 kc.

5-13. TOP AND BOTTOM COVER REMOVAL.

5-14. For access to circuit components, remove the top and bottom covers. When repairing the frequency-selector switch assemblies (S101 through S103); or, when replacing multiplier switch S104, remove the side covers as well. To remove covers, refer to Figure 5-3, and proceed as follows:

- a. Remove screws from top and bottom covers as shown in Figure 5-3.
- b. Slide covers to rear, lift to remove.
- c. Side covers: remove four screws on each side which hold cover.

5-15. CALIBRATION PROCEDURE.

5-16. The calibration procedure should be made only after the Model 241A is determined to be out of adjustment using the Performance Check, Paragraph 5-5. If your instrument fails to satisfy any one of the requirements given in the following steps, carefully recheck the cable connections and procedure. If the Oscillator still fails the step, refer to Paragraph 5-32, Troubleshooting, for possible cause and corrective action.

5-17. Perform specific tests associated with the particular sections of the instrument shown to be faulty by the Performance Check (Paragraphs 5-5 to 5-13). Indiscriminate adjustment of the internal controls to "refine" the settings should be avoided.

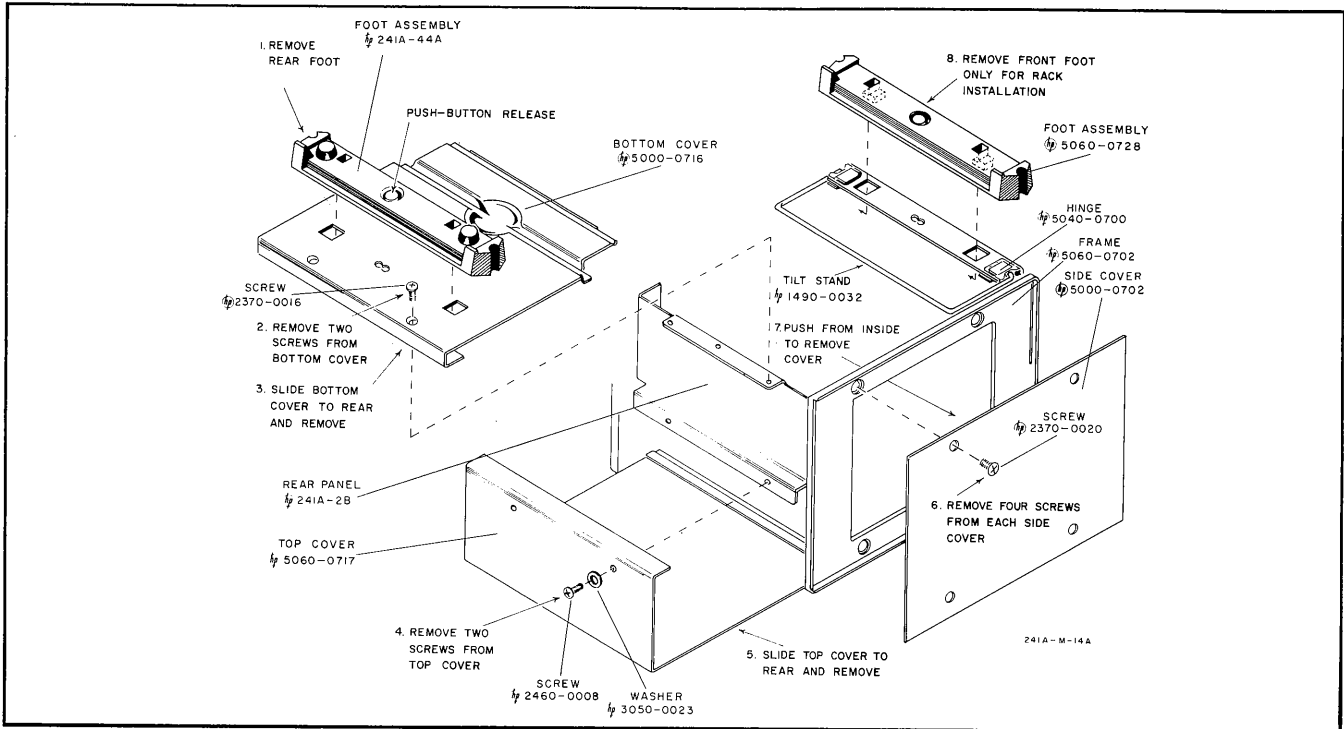

Figure 5-3. Cover Removal

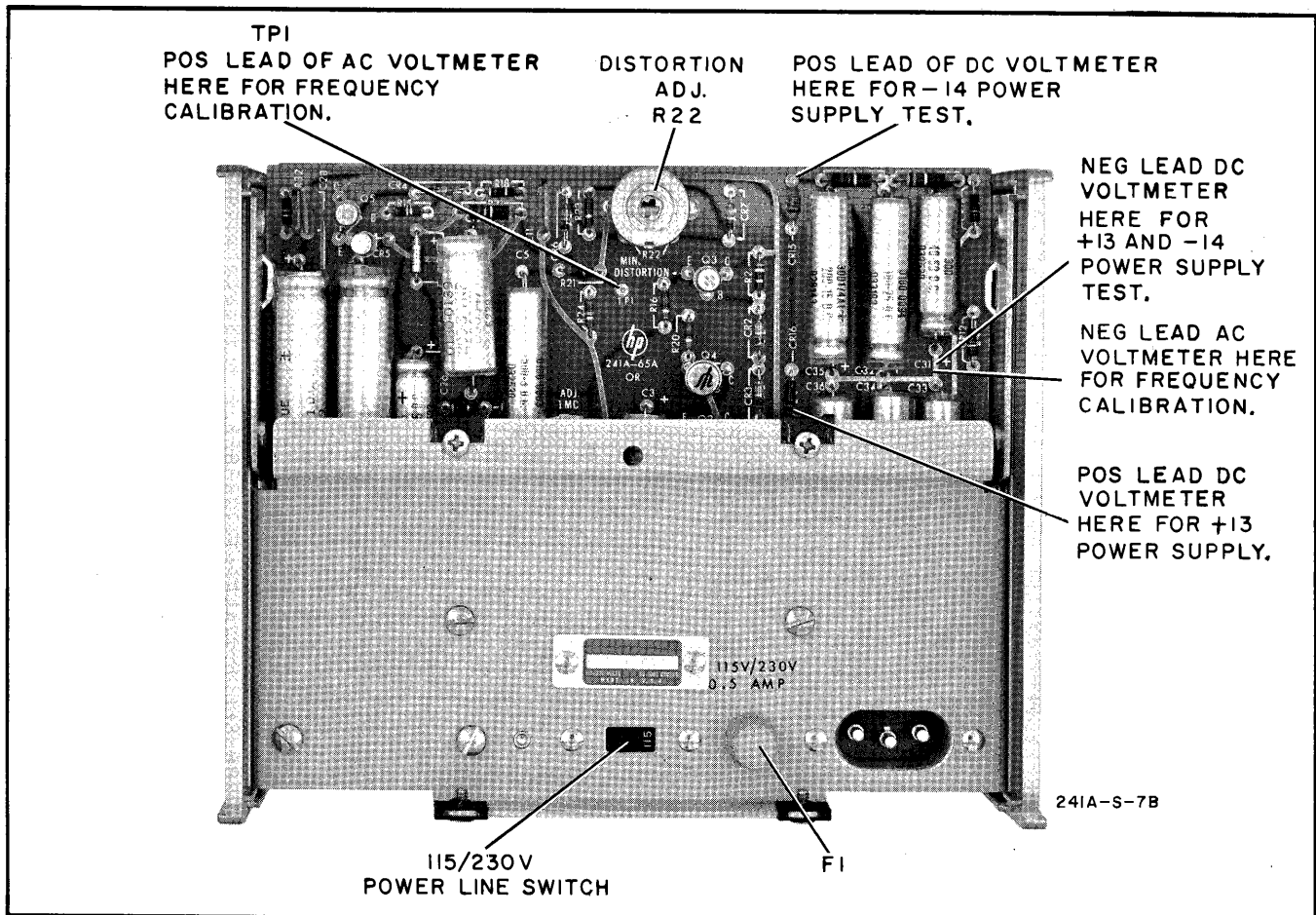

Figure 5-4. Rear View

5-18. POWER SUPPLY.

- a. Remove top cover from Model 241A cabinet. (Refer to Figure 5-3.)
- b. Measure +13 volt supply using a DC Voltmeter (Ⓢ Model 412A); connect the common lead to the junction of C31, C32, and C33 and the volts probe to the cathode of CR16. (Refer to Figure 5-4.)
- c. Connect Ⓢ Model 241A to a variable auto transformer and adjust the line voltage to 115 volts.
- d. The DC Voltmeter should indicate between +12.0 to +13.5 volts.
- e. Vary input line voltage with the variable auto transformer from 103.5 to 126.5 volts; DC Voltmeter indication should not change more than ±0.75 volts from the reading, observed in Step d.
- f. Connect common lead of DC Voltmeter to the junction of C33 and C34, Volts probe to the anode of CR15 (see Figure 5-4).
- g. Adjust variable auto transformer to 115 volts; DC Voltmeter should read between -13.0 to -15.0 volts.
- h. Vary input line voltage with the variable auto transformer from 103.5 to 126.5 volts; DC Voltmeter indication should not change more than ±0.75 volts from the reading observed in Step g.
- j. Disable the oscillator by depressing a MULTIPLIER button half way and then releasing all range buttons. All range buttons should then be in released position.
- k. Measure the AC ripple across the +13 and -14 volt supply using an AC Voltmeter (Ⓢ Model 400H). Connect AC Voltmeter using a shielded cable with short clip leads to the test points described in Steps b and f.
- m. The AC ripple across each supply should be less than 2 millivolts rms.

- n. Measure DC Voltage between ground and junction of R16 and R20 (see Figure 5-5). Adjust the value of R7 to obtain a reading of -1.0 ±0.5 volts.

5-19. FREQUENCY CALIBRATION.

5-20. Frequency calibration of the x10 CPS, x100 CPS, x1 KC and x10 KC range consists of padding the capacitive element in the series and parallel arms of the Wein bridge circuit. Typical values are given in Table 5-4.

Table 5-4. Frequency Calibration

Range	Nominal Series C	Series Pad	Nominal Parallel C	Parallel Pad
x10 CPS	3.1 μfd	C102	3.1 μfd	C121
x100 CPS	0.31 μfd	C104	0.31 μfd	C123
x1 KC	0.031 μfd	C105	0.031 μfd	C124
x10 KC	3100 pf	C106	3100 pf	C125

NOTE

The AC error voltage test point (TP1) on the rear circuit board is used to monitor bridge balance. A 1% increase in the series capacitance will decrease the frequency by 0.5% and increase the error voltage by 12 mv. A 1% increase in the parallel capacitance will decrease the frequency by 0.5% and decrease the error voltage by 12 millivolts.

5-21. x1 KC RANGE.

- a. Connect Model 241A as shown in Figure 5-1.
- b. Set Model 241A controls as follows:
MULTIPLIER. x1 KC
FREQUENCY Pushbuttons 5.00
VERNIER. CAL.
AMPLITUDE MAX.
- c. Connect common lead of an AC Voltmeter (Ⓢ Model 400H) to the junction of C33 and C32, positive lead to Test Point TP1 (See Figure 5-4.)
- d. Adjust R22 for a minimum reading on AC Voltmeter.
- e. Select the value of C105 and C124 (see Table 5-4) for an indication of 5000 cps ±50 cps on the Electronic Counter and an error voltage indication of 105 mv ±5 millivolts on AC Voltmeter.

NOTE

Frequency should be measured with the AC Voltmeter lead removed from Test Point TP1.

- f. Check frequency and error voltage at buttons 1.00, 2.00, 7.00, and 9.00. Frequency should be within 1% of selected value and error voltage between 95 and 115 millivolts. If necessary, repeat Step e selecting the value of C105 and C124 for optimum performance.

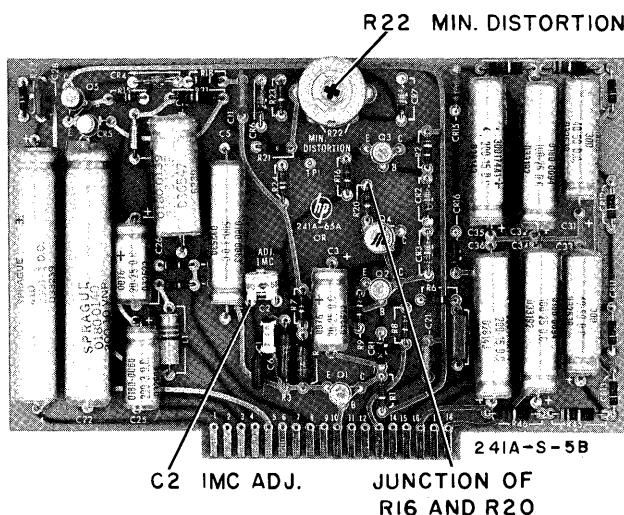

Figure 5-5. Amplifier Board Assembly

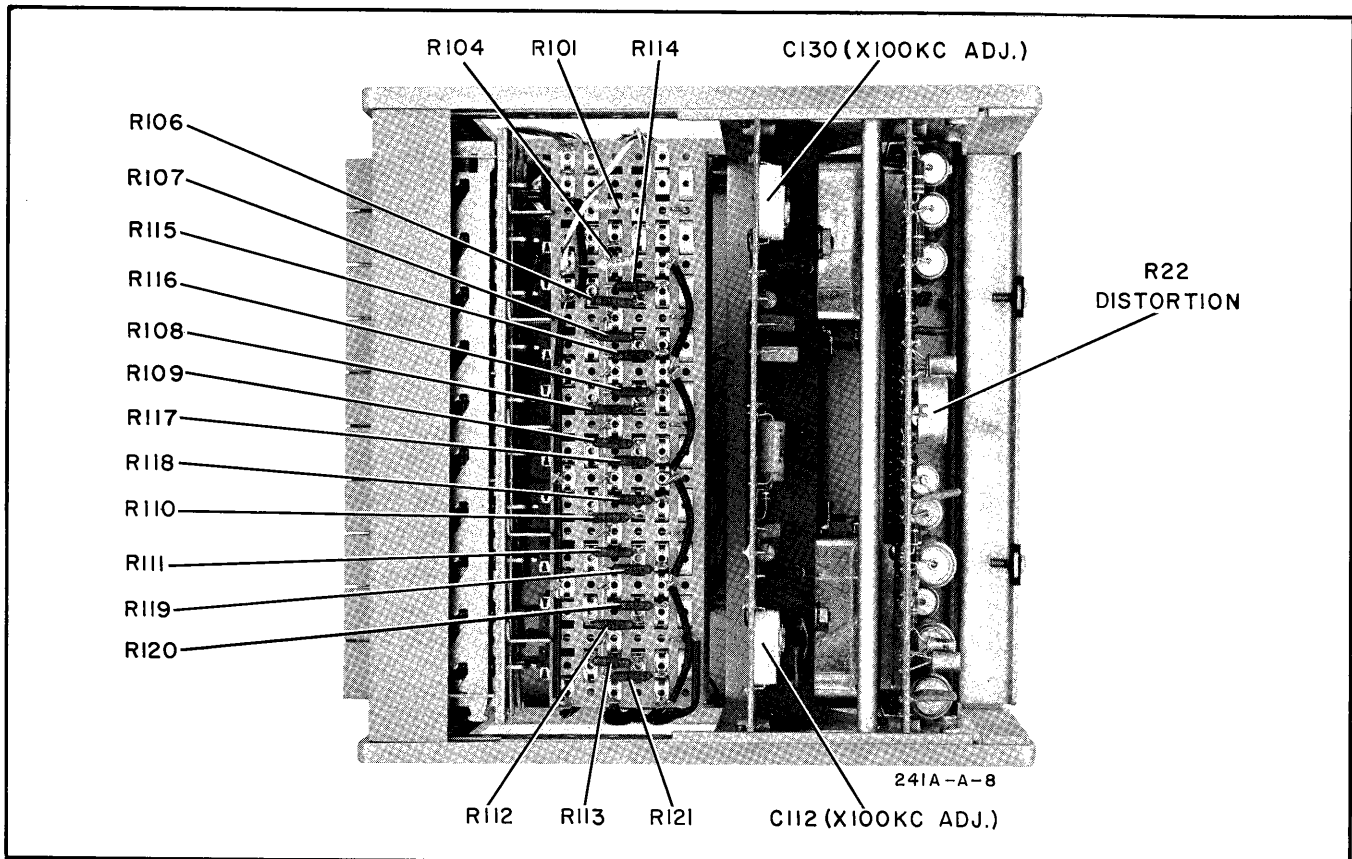

Figure 5-6. Top View

5-22. x100 CPS RANGE.

- a. Set Electronic Counter FUNCTION switch to 10 PERIOD AVERAGE; set Model 241A FREQUENCY controls to 5.00 x 100 CPS.
- b. Select value of C104 and C123 for an indication of 2 ms \pm 0.02 milliseconds on Electronic Counter and an error voltage indication of 105 mv \pm 5.0 millivolts on AC Voltmeter.
- c. Check frequency and error voltage at 100, 200, 700, and 900 cps. Frequency should be within 1% of selected value and error voltage between 95 and 115 millivolts. If necessary, repeat Step b selecting the value of C104 and C123 for optimum adjustment.

5-23. x10 CPS RANGE.

- a. Set Model 241A FREQUENCY controls to 5.00 x 10 CPS.
- b. Select value of C102 and C121 (see Table 5-4) for an indication of 20 milliseconds \pm 2 ms on the Electronic Counter (10 PERIOD AVERAGE) and an error voltage indication on AC Voltmeter of 105 mv \pm 5.0 millivolts.
- c. Check frequency and error voltage at 10, 20, 70, and 90 cps. Frequency should be within 1% of selected value and error voltage between 95 and 115 millivolts. If necessary, select value of C102 and C121 for optimum performance.

5-24. x100 KC RANGE.

- a. Set the 241A frequency controls to 1.00 x 100 KC.
- b. Set Electronic Counter FUNCTION switch to measure FREQUENCY.
- c. Adjust trimmer capacitors C112 and C130 (see Figure 5-7) for a frequency indication of 100.2 kc with an error voltage indication of 115 millivolts.

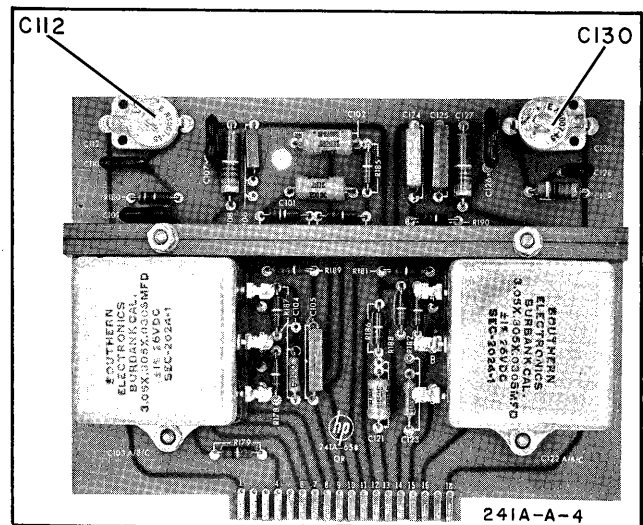

Figure 5-7. Range Capacitor Board Assembly

NOTE

Frequency should be set high as the frequency will decrease by 0.2% when the covers are installed.

- d. Set 241A frequency controls to 9.00 x 100 KC.
- e. Adjust C2 (see Figure 5-5) for an indication of 903 KC.
- f. Check frequency and error voltage at 100, 200, 700, and 900 KC. Frequency should be within 1% of selected value and error voltage should be between 90 and 125 millivolts. If necessary, adjust C2, C112, and C130 for optimum performance.

5-25. x10 KC RANGE.

- a. Set the 241A frequency controls to 5.00 x 10 KC.
- b. Set Electronic Counter FUNCTION switch to measure FREQUENCY.
- c. Select value of C106 and C125 for a frequency indication of 50 kc ±500 cps and an error voltage indication of 105 mv ±5 mv.
- d. Check frequency and error voltage at 10, 20, 70, and 90 KC. Frequency should be within 1% of selected value and error voltage between 95 and 115 mv. If necessary, adjust C106 and C125 for optimum performance.

5-26. DISTORTION ADJUSTMENT.

- a. Connect Model 241A as shown in Figure 5-2.
- b. Set the Model 241A as follows:
MULTIPLIER. x1 KC
FREQUENCY Pushbuttons 1.00
AMPLITUDE MAX.
VERNIER. CAL.
- c. Set the Distortion Analyzer controls as follows:
FREQUENCY RANGE x100
INPUT AF
FUNCTION SET LEVEL
METER RANGE 100%
- d. Adjust INPUT SENSITIVITY for full-scale reading (1.0).
- e. Set FUNCTION switch to DISTORTION.
- f. Adjust FINE and COARSE frequency controls and BALANCE control for a null on Distortion Analyzer Meter at fundamental frequency (1 kc); switch METER RANGE as necessary to obtain upscale meter reading.
- g. Adjust R22 (see Figure 5-4) for a minimum reading on the Distortion Analyzer.

5-27. FREQUENCY SELECTOR SWITCH ASSEMBLY REPLACEMENT.

5-28. Multiplier switch S104 and the three frequency selector switch assemblies (S101 through S103) are a single switch unit in the oscillator; however, each switch assembly is individually replaceable. To replace an assembly, it is necessary to remove the switch unit first.

- a. Remove top, bottom, and side covers from oscillator.
- b. Remove front side screws (two on each side) which hold plastic mounting plate of the switch unit to chassis.
- c. Swing front panel and switch unit away from oscillator.
- d. Note and sketch wire connections to defective frequency selector switch assembly, and then unsolder those connections.
- e. Slide switch unit away from front panel, and remove all frequency pushbuttons from it.

NOTE

When prying pushbuttons off, use equal pressure on both sides of button.

- f. Remove three screws which are holding defective switch unit to plastic mounting plate. These screws are on front panel side of mounting plate.
- g. Slip defective switch out of the unit and install replacement switch.

CAUTION

AVOID TOUCHING THE SWITCH WAFERS AS OIL FROM YOUR HAND WILL DEGRADE INSTRUMENT PERFORMANCE.

- h. Attach replacement assembly to plastic mounting plate with three screws removed in Step f.
- j. Replace pushbuttons removed in Step e. Be sure pushbuttons are installed in correct numerical sequence.
- k. Slide switch unit into front panel and, using sketch made in Step d, resolder wire connections.
- m. Swing front panel and combined unit back into place in oscillator and replace front side screws removed in Step b.
- n. Perform the calibration procedure outlined in Paragraphs 5-15 through 5-26.

5-29. SERVICING ETCHED CIRCUIT BOARDS.

5-30. Model 241A has two plug-in type etched circuit boards. Plug-in type printed circuit boards are easily removed by pulling board firmly away from plug. Use care to avoid damaging components on the board.

5-31. The etched circuit boards in the Model 241A are plated through the eyelet holes. When servicing this type of board, components may be removed or replaced from either side of the board. For large components such as potentiometers, rotate heating of all leads while lifting the part from the board. You may also use a soldering tip such as Ungar #855 3/4 inch Cup Tip. In addition to the above, observe the following:

- a. Do not apply excessive heat.
- b. Apply heat to component lead, and remove lead with a straight outward pull.
- c. Use a toothpick or wooden splinter to clean holes.

- d. Do not force leads of replacement component into holes.

5-32. TROUBLESHOOTING.

5-33. To locate trouble in the Model 241A Oscillator, start with a thorough visual inspection; look for burned-out or loose components, loose connections, or any other similar condition which suggests a source of trouble. If visual inspection does not reveal the trouble, use the block diagram, Figure 4-1, and Troubleshooting Summary, Table 5-6, as guides in isolating the trouble. Figure 5-8 (used with Table 5-5) illustrates typical wave shapes that may be used as an aid in troubleshooting. Figures 5-3, 5-4, 5-5, 5-6, 5-7, and 5-9 can be used for identifying components in the Model 241A.

Table 5-5. Using Oscilloscope to Troubleshoot Oscillator

Set the $\text{\textcircled{P}}$ Model 241A Oscillator to the frequency indicated below and connect the $\text{\textcircled{P}}$ Model 175A Oscilloscope to test points a, b, or c (refer to Figure 5-10). The table below recommends what oscilloscope settings should be used, and Figure 5-8 illustrates the typical waveforms.

Frequency Setting of $\text{\textcircled{P}}$ Model 241A Oscillator	Test Point A	Test Point B	Test Point C (TP1)
10 CPS	Photograph #1 Vertical 1 v/cm Horizontal 20 ms/cm	Photograph #2 Vertical 10 mv/cm Horizontal 20 ms/cm	Photograph #3 Vertical 0.1 v/cm Horizontal 20 ms/cm
100 CPS	Photograph #4 Vertical 1 v/cm Horizontal 2 ms/cm	Photograph #5 Vertical 10 mv/cm Horizontal 2 ms/cm	Photograph #6 Vertical 0.1 v/cm Horizontal 2 ms/cm
1 KC	Photograph #7 Vertical 1 v/cm Horizontal 0.2 ms/cm	Photograph #8 Vertical 10 mv/cm Horizontal 0.2 ms/cm	Photograph #9 Vertical 0.1 v/cm Horizontal 0.2 ms/cm
10 KC	Photograph #10 Vertical 1 v/cm Horizontal 20 ms/cm	Photograph #11 Vertical 10 mv/cm Horizontal 20 ms/cm	Photograph #12 Vertical 0.1 v/cm Horizontal 20 ms/cm
100 KC	Photograph #13 Vertical 1 v/cm Horizontal 2 ms/cm	Photograph #14 Vertical 10 mv/cm Horizontal 2 ms/cm	Photograph #15 Vertical 0.1 v/cm Horizontal 2 ms/cm

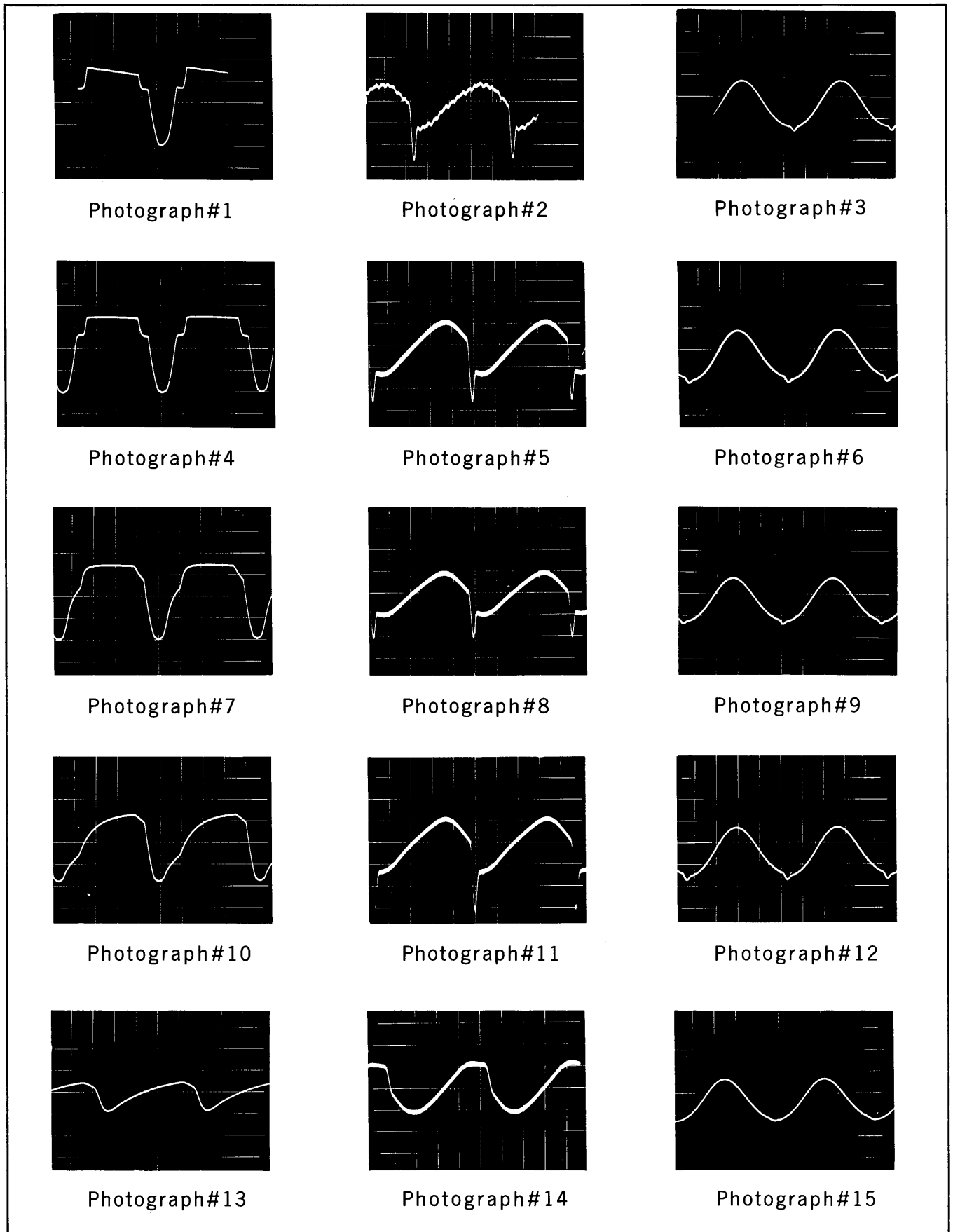

Figure 5-8 Typical Waveforms (see Table 5-5)

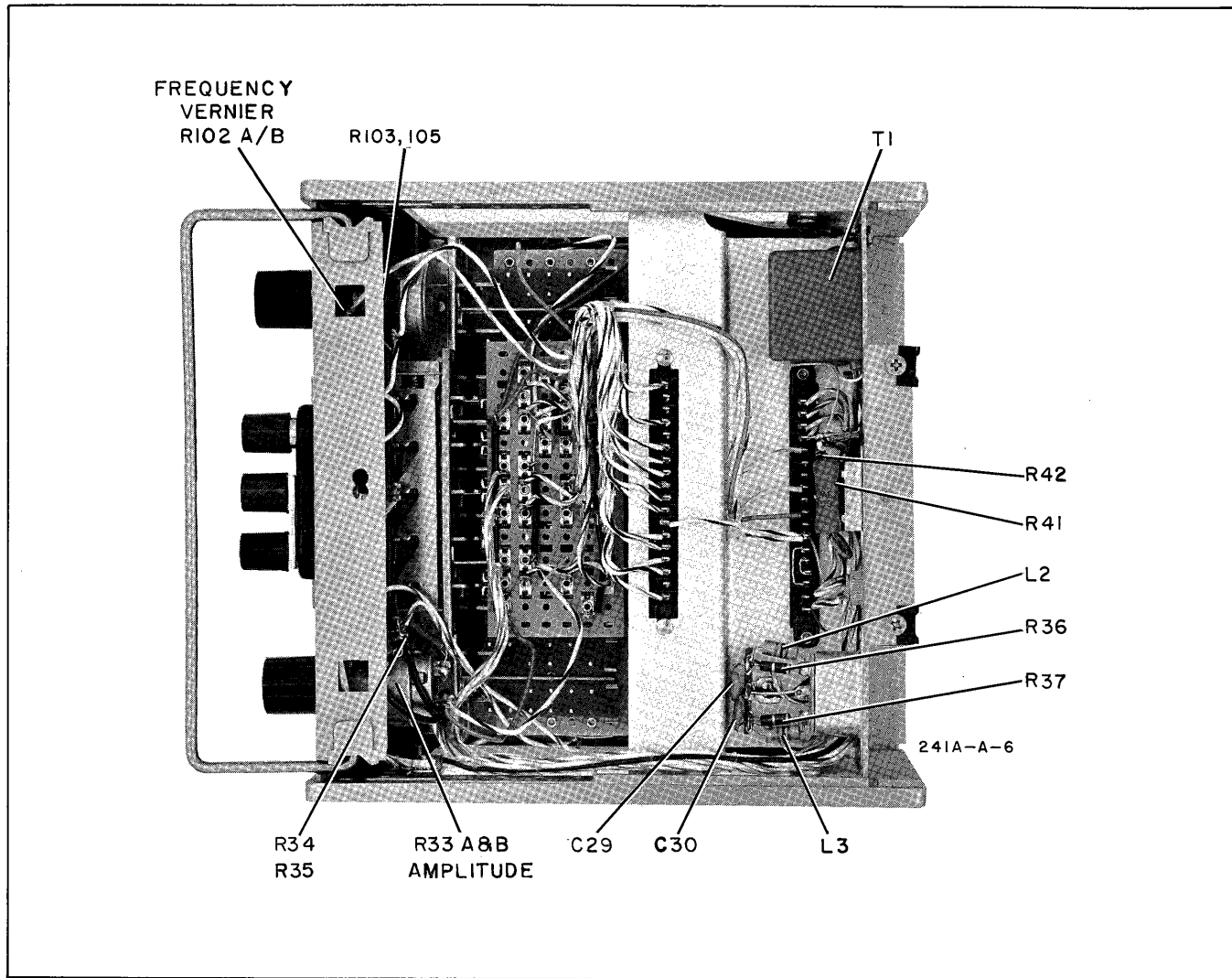
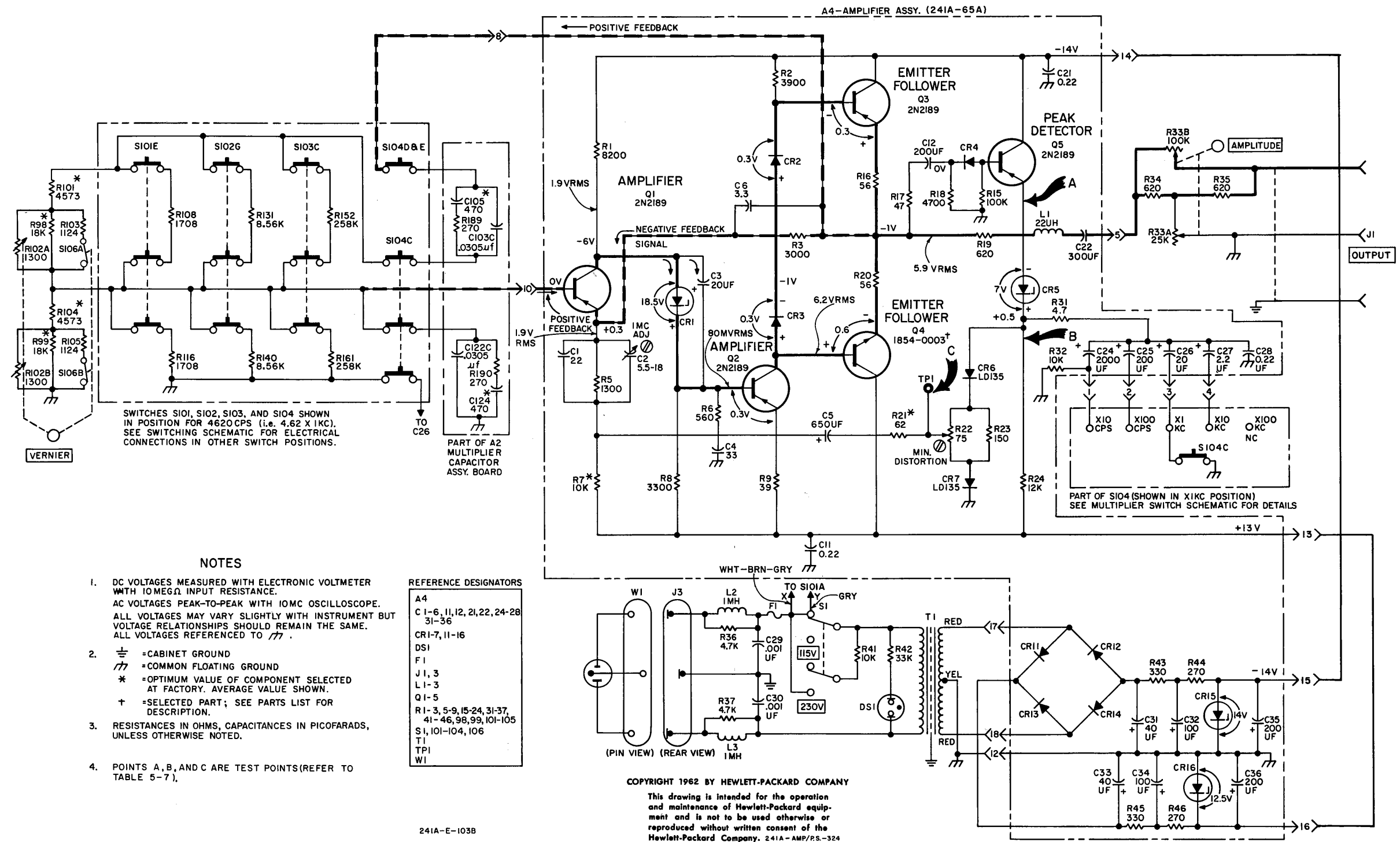

Figure 5-9. Bottom View

Table 5-6. Troubleshooting Summary

Indication	Action
No AC signal at junction of R16 and R20 for all range and frequency settings	Check power-supply voltages (+13 and -14 volts) Check peak detector circuit (Q5, CR4, CR5, CR6 and CR7) Check Q3, Q4, CR2 and CR3 for correct DC voltages (refer to Figure 5-10)
No output signal in one range	Check contacts of S104 Check components connected to Wien bridge in inoperative range (see Figure 5-11)
No output signal or distorted output signal at one setting of FREQUENCY pushbuttons	Check resistors connected to frequency switches at incorrect setting for proper value \pm percent of tolerance (refer to Table 6-1 for tolerances)
Incorrect frequency at one setting of FREQUENCY pushbuttons	Check all FREQUENCY switch contacts and resistors connected to Wien bridge at inoperative setting (see Figure 5-12)



SWITCHES S101, S102, S103, AND S104 SHOWN IN POSITION FOR 4620CPS (i.e. 4.62 X 1KC). SEE SWITCHING SCHEMATIC FOR ELECTRICAL CONNECTIONS IN OTHER SWITCH POSITIONS.

PART OF A2 MULTIPLIER CAPACITOR ASSY. BOARD

PART OF S104 (SHOWN IN X1KC POSITION) SEE MULTIPLIER SWITCH SCHEMATIC FOR DETAILS

NOTES

- DC VOLTAGES MEASURED WITH ELECTRONIC VOLTMETER WITH 10MEGΩ INPUT RESISTANCE. AC VOLTAGES PEAK-TO-PEAK WITH 10MC OSCILLOSCOPE. ALL VOLTAGES MAY VARY SLIGHTLY WITH INSTRUMENT BUT VOLTAGE RELATIONSHIPS SHOULD REMAIN THE SAME. ALL VOLTAGES REFERENCED TO ⏏.
- ⏏ = CABINET GROUND
⏏ = COMMON FLOATING GROUND
* = OPTIMUM VALUE OF COMPONENT SELECTED AT FACTORY. AVERAGE VALUE SHOWN.
† = SELECTED PART; SEE PARTS LIST FOR DESCRIPTION.
- RESISTANCES IN OHMS, CAPACITANCES IN PICOFARADS, UNLESS OTHERWISE NOTED.
- POINTS A, B, AND C ARE TEST POINTS (REFER TO TABLE 5-7).

REFERENCE DESIGNATORS

A4
C 1-6, 11, 12, 21, 22, 24-28, 31-36
CR1-7, 11-16
DS1
F1
J1, 3
L1-3
Q1-5
R1-3, 5-9, 15-24, 31-37, 41-46, 98, 99, 101-105
S1, 101-104, 106
T1
WI

241A-E-103B

COPYRIGHT 1962 BY HEWLETT-PACKARD COMPANY
This drawing is intended for the operation and maintenance of Hewlett-Packard equipment and is not to be used otherwise or reproduced without written consent of the Hewlett-Packard Company. 241A-AMP/PS-324

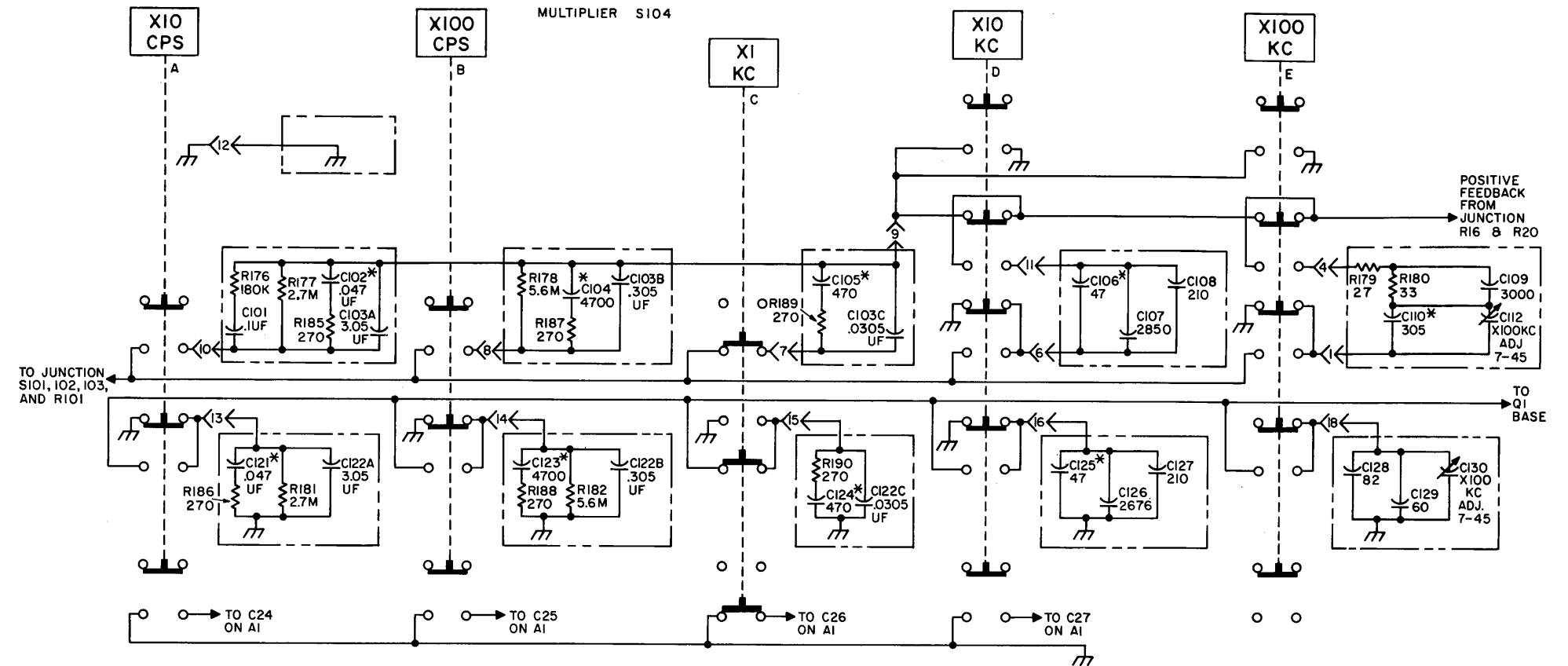

NOTES

1. SWITCH SHOWN FOR X1KC.
2. ONLY ONE PUSH BUTTON MAY BE DEPRESSED AT A TIME. A BUTTON DEPRESSED PREVIOUSLY IS RELEASED AUTOMATICALLY BY A NEW SELECTION.
3. RESISTANCE IN OHMS, CAPACITANCE IN PICO FARADS, UNLESS OTHERWISE NOTED.
4. --- = COMMON FLOATING, CIRCUIT GROUND.
* = FACTORY-SELECTED PART, AVERAGE VALUE SHOWN.
5. COMPONENTS ENCIRCLED BY DASHED (---) LINES ARE LOCATED ON A5 (241-65 B)

REFERENCE DESIGNATORS

A5
C101-110, 112, 121-130
R176-182, 185-190
S104

COPYRIGHT 1962 BY HEWLETT-PACKARD COMPANY

This drawing is intended for the operation and maintenance of Hewlett-Packard equipment and is not to be used otherwise or reproduced without written consent of the Hewlett-Packard Company. 241A-MULT. SW.-324

241A-E-303A

Figure 5-11. Multiplier Switch

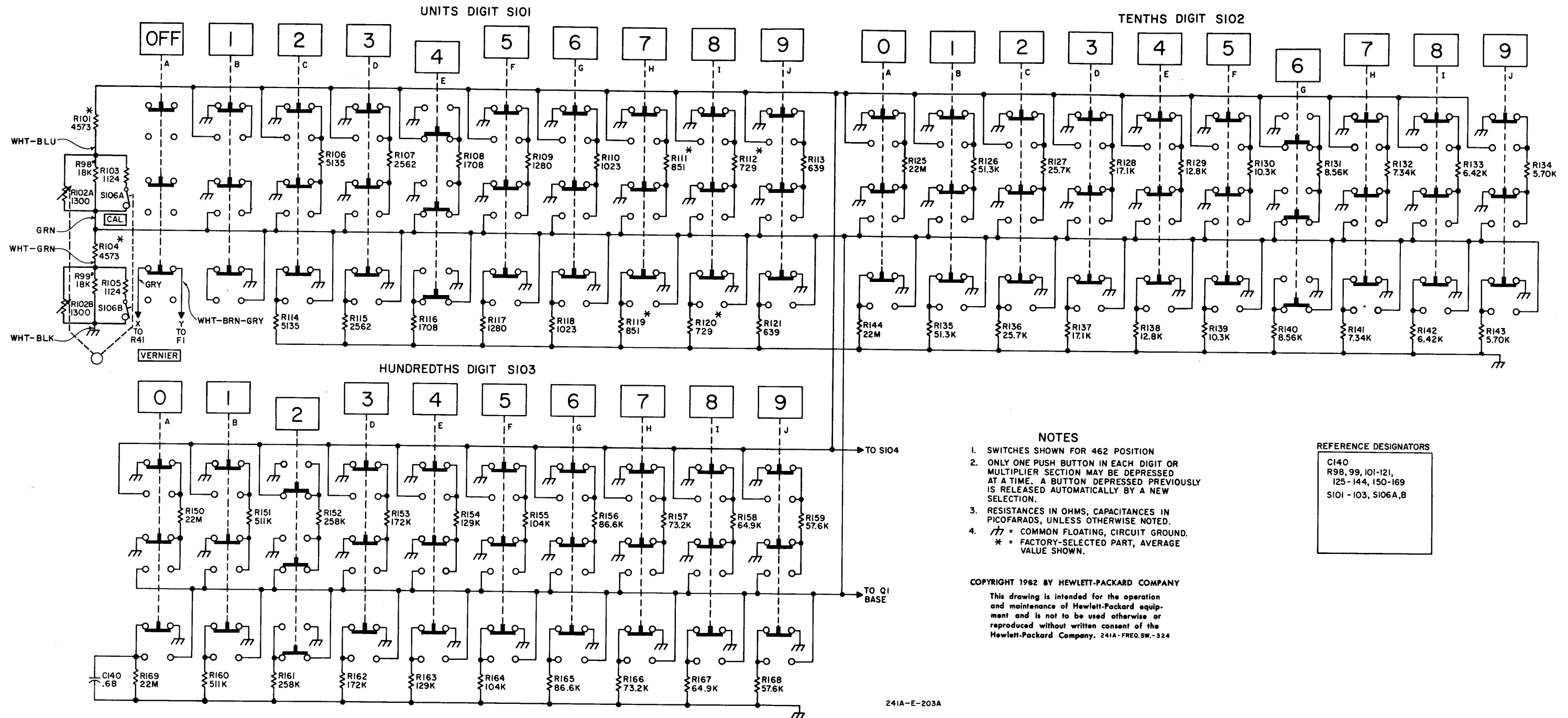

Figure 5-12. Frequency Selector Switch

SECTION VI REPLACEABLE PARTS

6-1. INTRODUCTION.

6-2. This section contains information for ordering replacement parts. Table 6-1 lists parts in alpha-numerical order of their reference designators and indicates the description and -hp- part number of each part, together with any applicable notes. Table 6-2 lists parts in alphanumeric order of their -hp- part number and provides the following information on each part:

- a. Description of the part (see list of abbreviations below).
- b. Typical manufacturer of the part in a five-digit code (see list of manufacturers in Appendix).
- c. Manufacturer's part number.
- d. Total quantity used in the instrument (TQ column).

6-3. Miscellaneous parts are listed at the end of Table 6-1.

6-4. ORDERING INFORMATION.

6-5. To obtain replacement parts, address order or inquiry to your local Hewlett-Packard Sales Office (see lists at rear of this manual for addresses). Identify parts by their Hewlett-Packard part numbers.

6-6. NON-LISTED PARTS.

6-7. To obtain a part that is not listed, include:

- a. Instrument model number.
- b. Instrument serial number.
- c. Description of the part.
- d. Function and location of the part.

REFERENCE DESIGNATORS

A = assembly	F = fuse	P = plug	V = vacuum tube, neon bulb, photocell, etc.
B = motor	FL = filter	Q = transistor	W = cable
C = capacitor	J = jack	R = resistor	X = socket
CR = diode	K = relay	RT = thermistor	XF = fuseholder
DL = delay line	L = inductor	S = switch	XDS = lampholder
DS = device signaling (lamp)	M = meter	T = transformer	Z = network
E = misc electronic part	MP = mechanical part		

ABBREVIATIONS

a = amperes	elect = electrolytic	mtg = mounting	rot = rotary
bp = bandpass	encap = encapsulated	my = mylar	rms = root-mean-square
bwo = backward wave oscillator	f = farads	NC = normally closed	rmo = rack mount only
c = carbon	fxd = fixed	Ne = neon	s-b = slow-blow
cer = ceramic	Ge = germanium	NO = normally open	Se = selenium
cmo = cabinet mount only	grd = ground (ed)	NPO = negative positive zero (zero temperature coefficient)	sect = section(s)
coef = coefficient	h = henries	nsr = not separately replaceable	Si = silicon
com = common	Hg = mercury	obd = order by description	sil = silver
comp = composition	impg = impregnated	p = peak	sl = slide
conn = connection	incd = incandescent	pc = printed circuit board	td = time delay
crt = cathode-ray tube	ins = insulation (ed)	pf = picofarads = 10^{-12} farads	TiO ₂ = titanium dioxide
dep = deposited	K = kilo = 1000	pp = peak to peak	tog = toggle
EIA = Tubes or transistors meeting Electronic Industries' Association standards will normally result in instrument operating within specifications; tubes and transistors selected for best performance will be supplied if ordered by $\text{\textcircled{C}}$ stock numbers.	lin = linear taper	piv = peak inverse voltage	tol = tolerance
	log = logarithmic taper	pos = position (s)	trim = trimmer
	m = milli = 10^{-3}	pot = potentiometer	tw = traveling wave tube
	M = megohms	rect = rectifier	var = variable
	ma = milliamperes		w/ = with
	μ = micro = 10^{-6}		W = watts
	minat = miniature		ww = wirewound
	mfgl = metal film on glass		w/o = without
	mfr = manufacturer		* = optimum value selected at factory, average value shown (part may be omitted)

Table 6-1. Reference Designation Index

REFERENCE DESIGNATION	-hp- PART NO.	DESCRIPTION	NOTE
A1	241A-19A	Frequency Selector Ass'y "A", includes: R101, R104 R106 thru R121 S101	
A2	241A-19B	Frequency Selector Ass'y "B", includes: R125 thru R144 S102	
A3	241A-19C	Frequency Selector Ass'y "C", includes: C140 R150 thru R169 S103	
A4	241A-65A	Board Ass'y Amp. and P.S., includes: C1 thru C6 Q1 thru Q5 C11, C12 R1 thru R3 C21, C22 R5 thru R9 C24 thru C28 R15 thru R24 C31 thru C36 R31, R32 CR1 thru CR7 R43 thru R46 CR11 thru CR16 L1	
A5	241A-65B	Board Ass'y Range Capacitor, includes: C101 thru C110 R176 thru R182 C112 R185 thru R190 C122 thru C130	
C1	0140-0145	C: fxd, mica, 22 pf $\pm 5\%$, 500 vdcw	
C2	0121-0036	C: var, cer, 5.5-18 pf	
C3	0180-0076	C: fxd, elect, 20 μf , 25 vdcw	
C4	0140-0100	C: fxd, 33 pf $\pm 5\%$, 500 vdcw	
C5	0180-1776	C: fxd, elect, 650 μf -10% +100%, 3 vdcw	
C6	0150-0059	C: fxd, cer, 3.3 pf, NPO, 600 vdcw	
C7 thru C10		Not Assigned	
C11	0160-0170	C: fxd, cer, 0.22 μf , 25 vdcw	
C12	0180-0139	C: fxd, 200 μf -10% +100%, 3 vdcw	
C13 thru C20		Not Assigned	
C21	0160-0170	C: fxd, cer, 0.22 μf , 25 vdcw	
C22	0180-0140	C: fxd, elect, 300 μf -10% +100%, 10 vdcw	
C23		Not Assigned	
C24	0180-0112	C: fxd, elect, 2000 pf, 1 vdcw	
C25	0180-0060	C: fxd, elect, 200 μf -10% +100%, 3 vdcw	
C26	0180-0076	C: fxd, elect, 20 μf , 25 vdcw	
C27	0180-0155	C: fxd, 2.2 μf $\pm 20\%$, 20 vdcw	
C28	0160-0170	C: fxd, cer, 0.22 μf , 25 vdcw	
C29 and C30	0160-0195	C: fxd, cer, 1000 pf $\pm 20\%$, 250 vdcw	
C31	0180-0050	C: fxd, elect, 40 μf -15% +100%, 50 vdcw	

Table 6-1. Reference Designation Index (Cont'd)

REFERENCE DESIGNATION	-hp- PART NO.	DESCRIPTION	NOTE
C32 C33 C34 C35 and C36 C37 thru C100	0180-0094 0180-0050 0180-0094 0180-0104	C: fxd, elect, 100 μ f, 25 vdcw C: fxd, elect, 40 μ f -15% +100%, 50 vdcw C: fxd, elect, 100 μ f, 25 vdcw C: fxd, elect, 200 μ f, 15 vdcw Not Assigned	
C101 C102*	0160-0168	C: fxd, mylar, 0.1 μ f, 10 vdcw *Optimum value selected at factory. (See Para. 5-19.)	
C103A/B/C C104*	0170-0076	C: fxd, poly, 3.05/.305/.0305 μ f *Optimum value selected at factory. (See Para. 5-19.)	
C105 and C106*		*Optimum value selected at factory. (See Para. 5-19.)	
C107 C108 C109 C110 C111	0160-0169 0160-0173 0140-0159 0140-0173	C: fxd, mica, 2850 pf \pm 1%, 300 vdcw C: fxd, cer, 210 pf \pm 10%, 500 vdcw C: fxd, 3000 pf, 300 vdcw C: fxd, mica, 305 pf \pm 1% Not Assigned	
C112 C113 thru C120 C121*	0130-0001	C: var, cer, 7-45 pf Not Assigned *Optimum value selected at factory. (See Para 5-19.)	
C122A/B/C C123 thru C125*	0170-0076	C: fxd, poly, 3.05/.305/.0305 μ f *Optimum value selected at factory. (See Para. 5-19.)	
C126 C127 C128 C129 C130	0140-0158 0160-0173 0140-0193 0160-0172 0130-0001	C: fxd, mica, 2676 pf \pm 1%, 500 vdcw C: fxd, cer, 210 pf \pm 10%, 500 vdcw C: fxd, 82 pf \pm 5%, 300 vdcw C: fxd, cer, 60 pf \pm 10%, 500 vdcw C: var, cer, 7-45 pf	
C131 thru C139 C140		Not Assigned C: fxd, 0.68 pf \pm 5%, 500 vdcw	
CR1 CR2 thru CR4 CR5 CR6 and CR7	1902-0054 1910-0016 1902-0072 1910-0016	Diode: semicon device, Si Diode: germanium Diode: Si Diode: germanium	
CR8 thru CR10 CR11 thru CR14		Not Assigned Diode: semicon device, Si	
CR15 CR16	1902-0040 1902-0031	Diode: semicon device, Si junc Diode: avalanche	
DS1	1450-0048	Light - indicator, red, NE2H	
F1	2110-0046	Fuse - cartridge, 1/2 am	

Table 6-1. Reference Designation Index (Cont'd)

REFERENCE DESIGNATION	-hp- PART NO.	DESCRIPTION	NOTE
J1 and J2 J3	1251-0148	Not Assigned Connector, power	
L1 L2 and L3	9140-0115 9140-0137	Coil - RF, 22 μ h, 10 w Coil - RF, fxd, 100 μ f	
Q1 thru Q3 Q4 Q5	1850-0096 1854-0003 1850-0096	Transistor: germanium, 2N2189, PNP Transistor: Si, NPN Transistor: germanium, 2N2189, PNP	
R1 R2 R3 R4 R5	0684-8221 0684-3921 0727-0124 Not Assigned 0721-0002	R: fxd, 8200 ohms \pm 10%, 1/4 w R: fxd, comp, 3900 ohms \pm 10%, 1/4 w R: fxd, dep C, 3000 ohms \pm 10%, 1 w Not Assigned R: fxd, dep C, 1300 ohms \pm 1%, 1/8 w	
R6 R7* R8 R9 R10 thru R14	0684-5611 0684-1031 0684-3321 0684-3901 Not Assigned	R: fxd, comp, 560 ohms \pm 10%, 1/4 w R: fxd, 10 K ohms \pm 10%, 1/4 w R: fxd, comp, 3300 ohms \pm 10%, 1/4 w R: fxd, comp, 39 ohms \pm 10%, 1/4 w Not Assigned	
R15 R16 R17 R18 R19	0684-1041 0684-5601 0684-4701 0684-4721 0683-6215	R: fxd, 100 K ohms \pm 10%, 1/4 w R: fxd, comp, 56 ohms \pm 10%, 1/4 w R: fxd, comp, 47 ohms \pm 10%, 1/4 w R: fxd, comp, 4700 ohms \pm 10%, 1/4 w R: fxd, comp, 620 ohms \pm 5%, 1/4 w	
R20 R21* R22 R23 R24	0684-5601 0683-6205 2100-0326 0684-1511 0684-1231	R: fxd, comp, 56 ohms \pm 10%, 1/4 w R: fxd, comp, 62 ohms \pm 5%, 1/4 w R: var, ww, lin, 75 ohms \pm 20%, 1.5 w R: fxd, comp, 150 ohms \pm 10%, 1/4 w R: fxd, comp, 12 K ohms \pm 10%, 1/4 w	
R25 thru R30 R31 R32 R33 R34 and R35	Not Assigned 0698-0001 0684-1031 2100-0113 0686-6215	Not Assigned R: fxd, comp, 4.7 ohms \pm 5%, 1/2 w R: fxd, 10 K ohms \pm 10%, 1/4 w R: var, comp, dual tandem, 2 w R: fxd, comp, 620 ohms \pm 5%, 1/2 w	
R36 and R37 R38 thru R40 R41 R42 R43	0687-4721 Not Assigned 0767-0008 0687-3331 0687-3311	R: fxd, comp, 4.7 K ohms \pm 10%, 1/2 w Not Assigned R: fxd, met flm, 10 K ohms \pm 5%, 3 w R: fxd, comp, 33 K ohms \pm 10%, 1/2 w R: fxd, comp, 330 ohms \pm 10%, 1/2 w	
R44 R45 R46 R47 thru R97 R98 and R99*	0687-2711 0687-3311 0687-2711 Not Assigned 0687-1831	R: fxd, comp, 270 ohms \pm 10%, 1/2 w R: fxd, comp, 330 ohms \pm 10%, 1/2 w R: fxd, comp, 270 ohms \pm 10%, 1/2 w Not Assigned R: fxd, comp, 18 K ohms \pm 10%, 1/2 w	
R100 R101* R102 R103 R104*	Not Assigned 0698-5435 2100-0343 0757-0157 0698-5435	Not Assigned R: fxd, met flm, 4573 ohms \pm 0.25%, 1/4 w R: var, comp, lin, dpst, 2 x 1300 ohms \pm 10%, 1 w R: fxd, met flm, 1124 ohms \pm 0.5%, 1/4 w R: fxd, met flm, 4573 ohms \pm 0.25%, 1/4 w	
R105 R106 R107	0757-0157 0698-5436 0698-5434	R: fxd, met flm, 1124 ohms \pm 0.5%, 1/4 w R: fxd, met flm, 5135 ohms \pm 0.25%, 1/4 w R: fxd, met flm, 2562 ohms \pm 0.25%, 1/4 w	

*Average value shown, optimum value selected at factory.

Table 6-1. Reference Designation Index (Cont'd)

REFERENCE DESIGNATION	-hp- PART NO.	DESCRIPTION	NOTE
R108	0698-5433	R: fxd, met flm, 1708 ohms $\pm 0.25\%$, 1/4 w	
R109	0698-5432	R: fxd, met flm, 1280 ohms $\pm 0.25\%$, 1/4 w	
R110	0698-5431	R: fxd, met flm, 1023 ohms $\pm 0.25\%$, 1/4 w	
R111*	0698-5430	R: fxd, met flm, 851 ohms $\pm 0.25\%$, 1/4 w	
R112*	0698-5429	R: fxd, met flm, 729 ohms $\pm 0.25\%$, 1/4 w	
R113	0698-5069	R: fxd, met flm, 639 ohms $\pm 0.25\%$, 1/4 w	
R114	0698-5436	R: fxd, met flm, 5135 ohms $\pm 0.25\%$, 1/4 w	
R115	0698-5434	R: fxd, met flm, 2562 ohms $\pm 0.25\%$, 1/4 w	
R116	0698-5433	R: fxd, met flm, 1708 ohms $\pm 0.25\%$, 1/4 w	
R117	0698-5432	R: fxd, met flm, 1280 ohms $\pm 0.25\%$, 1/4 w	
R118	0698-5431	R: fxd, met flm, 1023 ohms $\pm 0.25\%$, 1/4 w	
R119*	0698-5430	R: fxd, met flm, 851 ohms $\pm 0.25\%$, 1/4 w	
R120*	0698-5429	R: fxd, met flm, 729 ohms $\pm 0.25\%$, 1/4 w	
R121	0698-5069	R: fxd, met flm, 639 ohms $\pm 0.25\%$, 1/4 w	
R122 thru R124		Not Assigned	
R125	0687-2261	R: fxd, comp, 22 M ohms $\pm 10\%$, 1/2 w	
R126	0757-0113	R: fxd, met flm, 51.3 K ohms $\pm 1.0\%$, 1/4 w	
R127	0757-0112	R: fxd, met flm, 25.7 K ohms $\pm 1.0\%$, 1/4 w	
R128	0757-0111	R: fxd, met flm, 17.1 K ohms $\pm 1.0\%$, 1/4 w	
R129	0757-0110	R: fxd, met flm, 12.8 K ohms $\pm 10\%$, 1/4 w	
R130	0757-0109	R: fxd, met flm, 10.3 K ohms $\pm 1/2\%$, 1/4 w	
R131	0757-0108	R: fxd, met flm, 8.56 K ohms $\pm 1/2\%$, 1/4 w	
R132	0757-0107	R: fxd, met flm, 7.34 K ohms $\pm 1/2\%$, 1/4 w	
R133	0757-0106	R: fxd, met flm, 6.42 K ohms $\pm 1/2\%$, 1/4 w	
R134	0757-0105	R: fxd, met flm, 5.70 K ohms $\pm 1/2\%$, 1/4 w	
R135	0757-0113	R: fxd, met flm, 51.3 K ohms $\pm 1.0\%$, 1/4 w	
R136	0757-0112	R: fxd, met flm, 25.7 K ohms $\pm 1.0\%$, 1/4 w	
R137	0757-0111	R: fxd, met flm, 17.1 K ohms $\pm 1.0\%$, 1/4 w	
R138	0757-0110	R: fxd, met flm, 12.8 K ohms $\pm 10\%$, 1/4 w	
R139	0757-0109	R: fxd, met flm, 10.3 K ohms $\pm 1/2\%$, 1/4 w	
R140	0757-0108	R: fxd, met flm, 8.56 K ohms $\pm 1/2\%$, 1/4 w	
R141	0757-0107	R: fxd, met flm, 7.34 K ohms $\pm 1/2\%$, 1/4 w	
R142	0757-0106	R: fxd, met flm, 6.42 K ohms $\pm 1/2\%$, 1/4 w	
R143	0757-0105	R: fxd, met flm, 5.70 K ohms $\pm 1/2\%$, 1/4 w	
R144	0687-2261	R: fxd, comp, 22 M ohms $\pm 10\%$, 1/2 w	
R145 thru R149		Not Assigned	
R150	0687-2261	R: fxd, comp, 22 M ohms $\pm 10\%$, 1/2 w	
R151	0757-0169	R: fxd, met flm, 511 K ohms $\pm 1.0\%$, 1/4 w	
R152	0757-0121	R: fxd, met flm, 258 K ohms $\pm 1.0\%$, 1/4 w	
R153	0757-0120	R: fxd, met flm, 172 K ohms $\pm 1.0\%$, 1/4 w	
R154	0757-0119	R: fxd, met flm, 129 K ohms $\pm 1.0\%$, 1/4 w	
R155	0757-0118	R: fxd, met flm, 104 K ohms $\pm 1.0\%$, 1/4 w	
R156	0757-0117	R: fxd, met flm, 86.6 K ohms $\pm 1.0\%$, 1/4 w	
R157	0757-0116	R: fxd, met flm, 73.2 K ohms $\pm 1.0\%$, 1/4 w	
R158	0757-0115	R: fxd, met flm, 64.9 K ohms $\pm 1.0\%$, 1/4 w	
R159	0757-0114	R: fxd, met flm, 57.6 K ohms $\pm 1.0\%$, 1/4 w	
R160	0757-0169	R: fxd, met flm, 511 K ohms $\pm 1.0\%$, 1/4 w	
R161	0757-0121	R: fxd, met flm, 258 K ohms $\pm 1.0\%$, 1/4 w	

*Average value shown, optimum value selected at factory.

Table 6-1. Reference Designation Index (Cont'd)

REFERENCE DESIGNATION	-hp- PART NO.	DESCRIPTION	NOTE
R162	0757-0120	R: fxd, met flm, 172 K ohms $\pm 1.0\%$, 1/4 w	
R163	0757-0119	R: fxd, met flm, 129 K ohms $\pm 1.0\%$, 1/4 w	
R164	0757-0118	R: fxd, met flm, 104 K ohms $\pm 1.0\%$, 1/4 w	
R165	0757-0117	R: fxd, met flm, 86.6 K ohms $\pm 1.0\%$, 1/4 w	
R166	0757-0116	R: fxd, met flm, 73.2 K ohms $\pm 1.0\%$, 1/4 w	
R167	0757-0115	R: fxd, met flm, 64.9 K ohms $\pm 1.0\%$, 1/4 w	
R168	0757-0114	R: fxd, met flm, 57.6 K ohms $\pm 1.0\%$, 1/4 w	
R169	0687-2261	R: fxd, comp, 22 M ohms $\pm 10\%$, 1/2 w	
R170 thru R175		Not Assigned	
R176	0687-1841	R: fxd, comp, 180 K ohms $\pm 10\%$, 1/2 w	
R177	0687-2751	R: fxd, comp, 2.7 M ohms $\pm 10\%$, 1/2 w	
R178	0687-5651	R: fxd, comp, 5.6 M ohms $\pm 10\%$, 1/2 w	
R179	0687-2701	R: fxd, comp, 27 ohms $\pm 10\%$, 1/2 w	
R180	0687-3301	R: fxd, comp, 33 ohms $\pm 10\%$, 1/2 w	
R181	0687-2751	R: fxd, comp, 2.7 M ohms $\pm 10\%$, 1/2 w	
R182	0687-5651	R: fxd, comp, 5.6 M ohms $\pm 10\%$, 1/2 w	
R183 and R184		Not Assigned	
R185 thru R190	0687-2711	R: fxd, comp, 270 ohms $\pm 10\%$, 1/2 w	
S1	3101-0033	Switch - slide: DPDT, 115 - 230 v	
S2 thru S100		Not Assigned	
S101	3104-0001	Switch: 10 multi-pushbutton	
S102 and S103	3104-0002	Switch	
S104	3104-0003	Switch: 5 multi-pushbutton	
T1	9100-0120	Transformer - power	
XF1	1400-0110	Body, fuseholder	
<u>MISCELLANEOUS</u>			
	200CD-34	Output -attenuator, includes: R33 thru R35	
	241A-1D	Chassis	
	241A-2A	Panel - front	
	241A-2B	Panel - rear	
	241A-12A	Bracket - Switch Mtg.	
	241A-16A	Cable Ass'y, "A"	
	241A-16B	Cable Ass'y, "B"	
	241A-47A	Support	
	241A-65A-1	Board - Amplifier and P.S.	
	241A-65B-1	Board - Range Cap	
	241A-904	Manual - Operating and Service	
	425A-41C	Bushing - insulator	
	0340-0086	Insulator: B. P. double	
	0340-0091	Insulator: B. P. triple	
	0370-0026	Knob - 3/4" black (c arrow)	
	0370-0121	Pushbutton	
	1251-0141	Connector, P. C., 18 pin	

Table 6-1. Reference Designation Index (Cont'd)

REFERENCE DESIGNATION	-hp- PART NO.	DESCRIPTION	NOTE
<u>MISCELLANEOUS (Cont'd)</u>			
	1400-0111	Nut, retaining	
	1400-0112	Knob, fuseholder	
	1490-0032	Stand - Half Module Tilt	
	1510-0008	Ass'y, binding post - red	
	5000-0250	Pushbutton Label (Off)	
	5000-0254	Pushbutton Label (X10 cps)	
	5000-0256	Pushbutton Label (X100 cps)	
	5000-0257	Pushbutton Label (X1 kc)	
	5000-0258	Pushbutton Label (X10 kc)	
	5000-0259	Pushbutton Label (X100 kc)	
	5000-0260	Pushbutton Label (0)	
	5000-0262	Pushbutton Label (1)	
	5000-0264	Pushbutton Label (2)	
	5000-0266	Pushbutton Label (3)	
	5000-0268	Pushbutton Label (4)	
	5000-0270	Pushbutton Label (5)	
	5000-0272	Pushbutton Label (6)	
	5000-0274	Pushbutton Label (7)	
	5000-0276	Pushbutton Label (8)	
	5000-0702	Cover - 6H x 8L, screw-on	
	5000-0716	Bottom cover - 7W x 8L	
	5020-0701	Spacer - Half Mod Cabinet	
	5040-0700	Hinge	
	5060-0702	Frame Ass'y, 6H x 8L lub mod	
	5060-0717	Top cover ass'y, 7W x 8L half R	
	5060-0728	Foot Ass'y - half mod	
	5060-0625	Connector Ass'y	
	8120-0078	Cord Set - power SVT - 18Z3, 7.5 ft.	
	9211-0285	Carton	
	9220-0358	Foam Pad	

See introduction to this section

Table 6-2. Replaceable Parts

-hp- PART NO.	DESCRIPTION	MFR	MFR PART NO.	TQ
200CD-34	Output - attenuator, includes: R33 thru R35	28480	200CD-34	1
241A-1D	Chassis	28480	241A-1D	1
241A-2A	Panel - front	28480	241A-2A	1
241A-2B	Panel - rear	28480	241A-2B	1
241A-12A	Bracket - switch mtg.	28480	241A-12A	1
241A-16A	Cable Ass'y, "A"	28480	241A-16A	1
241A-16B	Cable Ass'y, "B"	28480	241A-16B	1
241A-19A	Frequency Selector Ass'y "A", includes: R101, R104 R106 thru R121 S101	28480	241A-19A	1
241A-19B	Frequency Selector Ass'y "B", includes: R125 thru R144 S102	28480	241A-19B	1
241A-19C	Frequency Selector Ass'y "C", includes: C140 R150 thru R169 S103	28480	241A-19C	1
241A-47A	Support	28480	241A-47A	1
241A-65A	Board Ass'y Amp. and P.S., includes: C1 - 6 L1 C11, 12 Q1 - 5 C21, 22 R1 - 3 C24 - 28 R5 - 9 C31 - 36 R15 - 24 CR1 - 7 R31, 32 CR11 - 16 R43 - 46	28480	241A-65A	1
241A-65A-1	Board Amplifier and P.S.	28480	241A-65A-1	1
241A-65B	Board Ass'y Range Capacitor, includes: C101 - 110 R176 - 182 C112 R185 - 190 C122 - C130	28480	241A-65B	1
241A-65B-1	Board - Range Capacitor	28480	241A-65B-1	1
241A-903	Manual - Operating and Service	28480	241A-903	1
425A-41C	Bushing - insulator	28480	425A-41C	1
0121-0036	C: var, cer, 5.5 - 18 pf	72982	538-006 NPO	1
0130-0001	C: var, cer, 7 - 45 pf	72982	50-3-061 P2P0	2
0140-0100	C: fxd, 33 pf $\pm 5\%$, 500 vdcw	00853	CM15E 330J	1
0140-0145	C: fxd, mica, 22 pf $\pm 5\%$, 500 vdcw	04062	PM15C 220J	1
0140-0158	C: fxd, mica, 2676 pf $\pm 1\%$, 500 vdcw	04062	DM20F 2676F	1
0140-0159	C: fxd, 3000 pf, 300 vdcw	04062	DM19F 302G	1
0140-0173	C: fxd, mica, 305 pf $\pm 1\%$	72136	DM19F3050F	1
0140-0193	C: fxd, 82 pf $\pm 5\%$, 300 vdcw	04062	VM15E 820J	1

See introduction to this section

Table 6-2. Replaceable Parts (Cont'd)

-hp- PART NO.	DESCRIPTION	MFR	MFR PART NO.	TQ
0150-0046	C: fxd, 0.68 pf $\pm 5\%$, 500 vdcw	78488	Type GA	1
0150-0059	C: fxd, 3.3 pf, NPO, 600 vdcw	72982	301 000 C0J0 339C	1
0160-0168	C: fxd, mylar, 0.1 μ f, 10 vdcw	28480	0160-0168	1
0160-0169	C: fxd, mica, 2850 pf $\pm 1\%$, 300 vdcw	14655	CD19E2	1
0160-0170	C: fxd, cer, 0.22 μ f, 25 vdcw	56289	5C9A	3
0160-0172	C: fxd, cer, 60 pf $\pm 10\%$, 500 vdcw	72982	Style 315 N2200	1
0160-0173	C: fxd, cer, 210 pf $\pm 10\%$, 500 vdcw	72982	316 N2200	2
0160-0195	C: fxd, cer, 1000 pf $\pm 20\%$, 250 vdcw	56289	19C51	2
0170-0076	C: fxd, poly, 3.05/.305/.0305 μ f	28480	0170-0076	2
0180-0050	C: fxd, elect, 40 μ f -15% +100%, 50 vdcw	56289	D32538	2
0180-0060	C: fxd, elect, 200 μ f -10% +100%, 3 vdcw	56289	30D11691	1
0180-0063	C: fxd, elect, 500 μ f -10% +100%, 3 vdcw	56289	30D12091	1
0180-0076	C: fxd, elect, 20 μ f, 25 vdcw	56289	40D18192	2
0180-0094	C: fxd, elect, 100 μ f, 25 vdcw	56289	30D18891	2
0180-0104	C: fxd, elect, 200 μ f, 15 vdcw	56289	30D17491	2
0180-0112	C: fxd, elect, 2000 pf, 1 vdcw	56289	41D Type 497217	1
0180-0139	C: fxd, 200 μ f -10% +100%, 3 vdcw	56289	4S609	1
0180-0140	C: fxd, elect, 300 μ f -10% +100%, 10 vdcw	56289	4S608	1
0180-0155	C: fxd, 2.2 μ f $\pm 20\%$, 20 vdcw	56289	150D225	1
0340-0086	Insulator: B. P. double	28480	0340-0086	1
0340-0091	Insulator: B. P. triple	28480	0340-0091	1
0370-0026	Knob - 3/4" black (c arrow)	28480	0370-0026	2
0370-0121	Pushbutton	28480	0370-0121	1
0683-6205*	R: fxd, comp, 62 ohms $\pm 5\%$, 1/4 w	01121	CB6205	1
0683-6215	R: fxd, comp, 620 ohms $\pm 5\%$, 1/4 w	01121	CB6215	1
0684-1031	R: fxd, 10 K ohms $\pm 10\%$, 1/4 w	01121	CB1031	2
0684-1041	R: fxd, 100 K ohms $\pm 10\%$, 1/4 w	01121	CB1041	1
0684-1231	R: fxd, comp, 12 K ohms $\pm 10\%$, 1/4 w	01121	CB1231	1
0684-1511	R: fxd, comp, 150 ohms $\pm 10\%$, 1/4 w	01121	CB1511	1
0684-3321	R: fxd, comp, 3300 ohms $\pm 10\%$, 1/4 w	01121	CB3321	1
0684-3901	R: fxd, comp, 39 ohms $\pm 10\%$, 1/4 w	01121	CB3901	1
0684-3921	R: fxd, comp, 3900 ohms $\pm 10\%$, 1/4 w	01121	CB3921	1
0684-4701	R: fxd, comp, 47 ohms $\pm 10\%$, 1/4 w	01121	CB4701	1
0684-4721	R: fxd, comp, 4700 ohms $\pm 10\%$, 1/4 w	01121	CB4721	1
0684-5601	R: fxd, comp, 56 ohms $\pm 10\%$, 1/4w	01121	CB5601	2
0684-5611	R: fxd, comp, 560 ohms $\pm 10\%$, 1/4 w	01121	CB5611	1
0684-8221	R: fxd, 820 ohms $\pm 10\%$, 1/4 w	01121	CB7211	1
0686-6215	R: fxd, comp, 620 ohms $\pm 5\%$, 1/2 w	01121	EB6215	2
0687-1831*	R: fxd, comp, 18 K ohms $\pm 10\%$, 1/2 w	01121	EB1831	2
0687-1841	R: fxd, comp, 180 K ohms $\pm 10\%$, 1/2 w	01121	EB1841	1
0687-2261	R: fxd, comp, 22 M ohms $\pm 10\%$, 1/2 w	01121	EB2261	3
0687-2701	R: fxd, comp, 27 ohms $\pm 10\%$, 1/2 w	01121	EB2701	2
0687-2711	R: fxd, comp, 270 ohms $\pm 10\%$, 1/2 w	01121	EB2711	8
0687-2751	R: fxd, comp, 2.7 M ohms $\pm 10\%$, 1/2 w	01121	EB2751	2
0687-3311	R: fxd, comp, 330 ohms $\pm 10\%$, 1/2 w	01121	EB3311	2
0687-3331	R: fxd, comp, 33 K ohms $\pm 10\%$, 1/2 w	01121	EB3331	1
0687-4721	R: fxd, comp, 4.7 ohms $\pm 10\%$, 1/2 w	01121	EB4721	2
0687-5651	R: fxd, comp, 5.6 M ohms $\pm 10\%$, 1/2 w	01121	EB5651	2

*Average value shown, optimum value selected at factory.

See introduction to this section

Table 6-2. Replaceable Parts (Cont'd)

-hp- PART NO.	DESCRIPTION	MFR	MFR PART NO.	TQ
0698-0001	R: fxd, comp, 4.7 ohms $\pm 5\%$, 1/2w	01121	EB47G5	1
0698-5429	R: fxd, met flm, 729 ohms $\pm 0.25\%$, 1/4w	75042	CEB T-3	2
0698-5430	R: fxd, met flm, 851 ohms $\pm 0.25\%$, 1/4w	75042	CEB T-3	2
0698-5431	R: fxd, met flm, 1023 ohms $\pm 0.25\%$, 1/4w	75042	CEB T-3	2
0698-5432	R: fxd, met flm, 1280 ohms $\pm 0.25\%$, 1/4w	75042	CEB T-3	2
0698-5433	R: fxd, met flm, 1780 ohms $\pm 0.25\%$, 1/4w	75042	CEB T-3	2
0698-5434	R: fxd, met flm, 2562 ohms $\pm 0.25\%$, 1/4w	75042	CEB T-3	2
0698-5435	R: fxd, met flm, 4573 ohms $\pm 0.25\%$, 1/4w	75042	CEB T-3	2
0698-5436	R: fxd, met flm, 5135 ohms $\pm 0.25\%$, 1/4w	75042	CEB T-3	2
0698-5069	R: fxd, met flm, 639 ohms $\pm 0.25\%$, 1/4w	75042	CEB T-3	2
0721-000 2	R: fxd, dep C, 1300 ohms $\pm 1\%$, 1/8w	19701	CF 12B	1
0727-0124	R: fxd, dep C, 3000 ohms $\pm 10\%$, 1 w	19701	DC1/2C	1
0757-0105	R: fxd, met flm, 5.70 K ohms $\pm 1/2\%$, 1/4w	19701	MFS1/4T-3	2
0757-0106	R: fxd, met flm, 6.42 K ohms $\pm 1/2\%$, 1/4 w	19701	MFS1/4T-3	2
0757-0107	R: fxd, met flm, 7.34 K ohms $\pm 1/2\%$, 1/4 w	19701	MFS1/4T-3	2
0757-0108	R: fxd, met flm, 8.56 K ohms $\pm 1/2\%$, 1/4 w	19701	MFS1/4T-3	2
0757-0109	R: fxd, met flm, 10.3 K ohms $\pm 1/2\%$, 1/4 w	19701	MFS1/4T-3	2
0757-0110	R: fxd, met flm, 12.8 K ohms $\pm 10\%$, 1/4 w	19701	MFS1/4T-0	2
0757-0111	R: fxd, met flm, 17.1 K ohms $\pm 1.0\%$, 1/4 w	19701	MFS1/4T-0	2
0757-0112	R: fxd, met flm, 25.7 K ohms $\pm 1.0\%$, 1/4 w	19701	MFS1/4T-0	2
0757-0113	R: fxd, met flm, 51.3 K ohms $\pm 1.0\%$, 1/4 w	19701	MFS1/4T-0	2
0757-0114	R: fxd, met flm, 57.6 K ohms $\pm 1.0\%$, 1/4 w	19701	MFS1/4T-0	2
0757-0115	R: fxd, met flm, 64.9 K ohms $\pm 1.0\%$, 1/4 w	19701	MFS1/4T-0	2
0757-0116	R: fxd, met flm, 73.2 K ohms $\pm 1.0\%$, 1/4 w	19701	MFS1/4T-0	2
0757-0117	R: fxd, met flm, 86.6 K ohms $\pm 1.0\%$, 1/4 w	19701	MFS1/4T-0	2
0757-0118	R: fxd, met flm, 104 K ohms $\pm 1.0\%$, 1/4 w	19701	MFS1/4T-0	2
0757-0119	R: fxd, met flm, 129 K ohms $\pm 1.0\%$, 1/4 w	19701	MFS1/4T-0	2
0757-0120	R: fxd, met flm, 172 K ohms $\pm 1.0\%$, 1/4 w	19701	MFS1/4T-0	2
0757-0121	R: fxd, met flm, 258 K ohms $\pm 1.0\%$, 1/4 w	19701	MFS1/4T-0	2
0757-0157	R: fxd, met flm, 1.24 ohms $\pm 0.5\%$, 1/4 w	19701	MFS1/2T-3	2
0757-0169	R: fxd, met flm, 511 K ohms $\pm 1.0\%$, 1/4 w	19701	MFS1/4T-0	2
0767-0008	R: fxd, met flm, 10 K ohms $\pm 5\%$, 3 w	07115	LP13	1
1251-0141	Connector, P. C., 18 pin	95354	SD-618UR	2
1251-0148	Connector, power	0000U	H1061-1G-3L	1
1400-0110	Body, fuseholder	71400	obd#	1
1400-0111	Nut, retaining	71400	obd#	1
1400-0112	Knob, fuseholder	71400	obd#	1
1450-0048	Light - indicator, red, NE2H	08717	858R	1
1490-0032	Stand - Half Module Tilt	28480	1490-0032	1
1510-0008	Ass'y, binding post - red	28480	1510-0008	2
1850-0096	Transistor: germanium, 2N2189, PNP	01295	2N2189	3
1854-0003	Transistor: Si, NPN	28480	1854-0003	1
1901-0025	Diode: semicon device, Si	28480	1901-0025	4
1902-0031	Diode: avalanche	28480	1902-0031	1
1902-0040	Diode: semicon device, Si junction	28480	1902-0040	1
1902-0054	Diode: semicon device, Si	28480	1902-0054	1
1902-0072	Diode: Si	07910	CD34116	1
1910-0016	Diode: germanium	82219	D2361	3

*Average value shown, optimum value selected at factory.

Table 6-2. Replaceable Parts (Cont'd)

-hp- PART NO.	DESCRIPTION	MFR	MFR PART NO.	TQ	
2100-0113	R: var, comp, dual tandem, 2 w	01121	JJ59160	1	
2100-0326	R: var, ww, lin, 75 ohms $\pm 20\%$, 1.5 w	28480	2100-0326	1	
2100-0343	R: var, comp, lin dpst, 2 x 1200 ohms $\pm 10\%$, 1 w	28480	2100-0343	1	
2110-0046	Fuse - cartridge, 1/2 am	28480	2110-0046	1	
3101-0033	Switch - side: DPDT, 115 - 230 v	42190	4633	1	
3104-0001	Switch: 10 multi-pushbutton	04009	80994-H	1	
3104-0002	Switch	28480	3104-0002	2	
3104-0003	Switch: 5 multi-pushbutton	28480	3104-0003	1	
5000-0250	Pushbutton Label (Off)	28480	5000-0250	1	
5000-0254	Pushbutton Label (X10 cps)	28480	5000-0254	1	
5000-0256	Pushbutton Label (X100 cps)	28480	5000-0256	1	
5000-0257	Pushbutton Label (X1 kc)	28480	5000-0257	1	
5000-0258	Pushbutton Label (X10 kc)	28480	5000-0258	1	
5000-0259	Pushbutton Label (X100 kc)	28480	5000-0259	1	
5000-0260	Pushbutton Label (0)	28480	5000-0260	1	
5000-0262	Pushbutton Label (1)	28480	5000-0262	1	
5000-0264	Pushbutton Label (2)	28480	5000-0264	1	
5000-0266	Pushbutton Label (3)	28480	5000-0266	1	
5000-0268	Pushbutton Label (4)	28480	5000-0268	1	
5000-0270	Pushbutton Label (5)	28480	5000-0270	1	
5000-0272	Pushbutton Label (6)	28480	5000-0272	1	
5000-0274	Pushbutton Label (7)	28480	5000-0274	1	
5000-0276	Pushbutton Label (8)	28480	5000-0276	1	
5000-0702	Cover - 6H x 8L, screw-on	28480	5000-0702	1	
5000-0716	Bottom cover - 7W x 8L	28480	5000-0716	1	
5020-0701	Spacer - Half Mod Cabinet	28480	5020-0701	1	
5040-0700	Hinge	28480	5040-0700	1	
5060-0702	Frame ass'y, 6H x 8L lub mod	28480	5060-0702	1	
5060-0717	Top cover ass'y, 7W x 8L half R	28480	5060-0717	1	
5060-0728	Foot ass'y - half mod	28480	5060-0728	1	
5060-0625	Connector ass'y	28480	5060-0625	1	
9100-0120	Transformer - power	28480	9100-0120	1	
9140-0115	Coil - RF, 22 μ h, 10 w	99800	2150-32	1	
9140-0137	Coil - RF, fxd, 100 μ f	28480	9140-0137	2	

See introduction to this section

APPENDIX CODE LIST OF MANUFACTURERS (Sheet 1 of 2)

The following code numbers are from the Federal Supply Code for Manufacturers Cataloging Handbooks H4-1 (Name to Code) and H4-2 (Code to Name) and their latest supplements. The date of revision and the date of the supplements used appear at the bottom of each page. Alphabetical codes have been arbitrarily assigned to suppliers not appearing in the H4 handbooks.

Code No.	Manufacturer	Address	Code No.	Manufacturer	Address	Code No.	Manufacturer	Address	Code No.	Manufacturer	Address
00000	U. S. A. Common	Any supplier of U. S.	07115	Corning Glass Works	Bradford, Pa.	24655	General Radio Co.	West Concord, Mass.	73293	Hughes Products Division of	Newport Beach, Calif.
00136	McCoy Electronics	Mount Holly Springs, Pa.	07126	Electronic Components Dept.	Pasadena, Calif.	26365	Gries Reproducer Corp.	New Rochelle, N. Y.	73445	Ampex Electronic Co., Div. of North	Hicksville, N. Y.
00213	Sage Electronics Corp.	Rochester, N. Y.	07137	Transistor Electronics Corp.	Minneapolis, Minn.	26462	Grobet File Co. of America, Inc.	Carlstadt, N. J.	73490	American Phillips Co., Inc.	San Pasadena, Calif.
00334	Humidil Co.	Colton, Calif.	07138	Westinghouse Electric Corp.	Electronics Tube Div.	26592	Hamilton Watch Co.	Lancaster, Pa.	73506	Beckman Helipot Corp.	Hamden, Conn.
00335	Westrex Corp.	New York, N. Y.	07149	Electronic Tube Div.	Elmira, N. Y.	28480	Hewlett-Packard Co.	Palo Alto, Calif.	73509	Bradley Semiconductor Corp.	Hartford, Conn.
00373	Garlock Packing Co.,		07233	Filmohm Corp.	New York, N. Y.	33173	G. E. Receiving Tube Dept.	Owensboro, Ky.	73559	Carling Electric, Inc.	Hartford, Conn.
00656	Aerovox Corp.	New Bedford, Mass.	07261	Cinch-Graphix Co.	City of Industry, Calif.	35434	Lectrohm Inc.	Chicago, Ill.	73682	George K. Garrett Co., Inc.	Philadelphia, Pa.
00779	Amp, Inc.	Harrisburg, Pa.	07263	Avnet Corp.	Los Angeles, Calif.	36196	Stanwyck Corp.	Hawkesbury, Ontario, Canada	73734	Federal Screw Prod. Co.	Chicago, Ill.
00781	Aircraft Radio Corp.	Boonton, N. J.	07263	Fairchild Semiconductor Corp.	Mountain View, Calif.	37942	P. R. Mallory & Co., Inc.	Indianapolis, Ind.	73743	Fischer Special Mfg. Co.	Cincinnati, Ohio
00815	Northern Engineering Laboratories, Inc.	Burlington, Wis.	07322	Minnesota Rubber Co.	Minneapolis, Minn.	39543	Mechanical Industries Prod. Co.	Akron, Ohio	73793	The General Industries Co.	Elyria, Ohio
00853	Sangamo Electric Company,		07387	The Birtcher Corp.	Los Angeles, Calif.	40920	Minature Precision Bearings, Inc.	Keene, N. H.	73846	Goshen Stamping & Tool Co.	Goshen, Ind.
00866	Goe Engineering Co.	Los Angeles, Calif.	07700	Technical Wire Products	Springfield, N. J.	42190	Muter Co.	Chicago, Ill.	73899	JFD Electronics Corp.	Brooklyn, N. Y.
00891	Carl E. Holmes Corp.	Los Angeles, Calif.	07930	Continental Device Corp.	Hawthorne, Calif.	43990	C. A. Norgren Co.	Englewood, Colo.	73905	Jennings Radio Mfg. Co.	San Jose, Calif.
01121	Allen Bradley Co.	Milwaukee, Wis.	07933	Rheem Semiconductor Corp.	Mountain View, Calif.	44655	Ohmite Mfg. Co.	Stokie, Ill.	74276	Signalite Inc.	Neptune, N. J.
01255	Litton Industries, Inc.	Beverly Hills, Calif.	07966	Shockley Semi-Conductor Laboratories	Palo Alto, Calif.	47904	Polaroid Corp.	Cambridge, Mass.	74455	J. H. Winns, and Sons	Winchester, Mass.
01281	TRW Semiconductors Inc.	Lawndale, Calif.	07980	Boonton Radio Corp.	Boonton, N. J.	48620	Precision Thermometer and Inst. Co.	Philadelphia, Pa.	74861	Industrial Condenser Corp.	Chicago, Ill.
01295	Texas Instruments, Inc.		08145	U. S. Engineering Co.	Los Angeles, Calif.	49956	Raytheon Company	Lexington, Mass.	74868	R. F. Products Division of Amphenol-	Danbury, Conn.
01349	The Alliance Mfg. Co.	Alliance, Ohio	08289	Blinn, Delbert, Co.	Pomona, Calif.	52090	Rowan Controller Co.	Baltimore, Md.	74970	E. F. Johnson Co.	Waseca, Minn.
01561	Chassi-Trak Corp.	Indianapolis, Ind.	08358	Burgess Battery Co.	Niagara Falls, Ontario, Canada.	63743	Ward Leonard Electric	U. T. Vernon, N. Y.	75042	Federal-Resistor Co.	Philadelphia, Pa.
01589	Pacific Relays, Inc.	Van Nuys, Calif.	08717	Sloan Company	Burbank, Calif.	54294	Shalcraft Mfg. Co.	Selma, N. C.	75173	Jones, Howard B., Division	Chicago, Ill.
01930	Amerock Corp.	Rockford, Ill.	08718	Cannon Electric Co., Phoenix Div.	Phoenix, Ariz.	55026	Simpson Electric Co.	Chicago, Ill.	75378	James Knights Co.	Sandwich, Ill.
01961	Pulse Engineering Co.	Santa Clara, Calif.	08792	CBS Electronics Semiconductor Operations, Div. of C. B. S., Inc.	Lowell, Mass.	55933	Snolone Corp.	Elmsford, N. Y.	75382	Kulka Electric Corporation	Mt. Vernon, N. Y.
02114	Ferrocube Corp. of America	Saugerties, N. Y.	08984	Mei-Rain	Indianapolis, Ind.	55938	Sorenson & Co., Inc.	So. Norwalk, Conn.	75818	Lenz Electric Mfg. Co.	Chicago, Ill.
02286	Cole Mfg. Co.	Palo Alto, Calif.	09026	Babcock Relays, Inc.	Costa Mesa, Calif.	56137	Spaulding Fibre Co., Inc.	Tonawanda, N. Y.	75915	Littlefuse Inc.	Des Plaines, Ill.
02660	Amphenol-Borg Electronics Corp.	Chicago, Ill.	09134	Texas Capacitor Co.	Houston, Texas	56289	Sprague Electric Co.	North Adams, Mass.	76005	Lord Mfg. Co.	Erie, Pa.
02735	Radio Corp. of America, Semiconductor and Materials Div.	Somerville, N. J.	09145	Altoh Electronics	Sun Valley, Calif.	59446	Telex, Inc.	St. Paul, Minn.	76210	C. W. Marwedel	San Francisco, Calif.
02771	Vocaline Co. of America, Inc.	Old Saybrook, Conn.	09250	Electro Assemblies, Inc.	Chicago, Ill.	59730	Thomas & Betts Co.	Elizabeth 1, N. J.	76433	Micamold Electronic Mfg. Corp.	Brooklyn, N. Y.
02777	Hopkins Engineering Co.	San Fernando, Calif.	09569	Mallory Battery Co. of Canada, Ltd.	Toronto, Ontario, Canada	60741	Tripplett Electrical Inc.	Bluffton, Ohio	76487	James Millen Mfg. Co., Inc.	Malden, Mass.
03508	G. E. Semiconductor Products Dept.	Syracuse, N. Y.	09664	The Bristol Co.	Waterbury, Conn.	61775	Union Switch and Signal, Div. of Westinghouse Air Brake Co.	Swissvale, Pa.	76493	J. W. Miller Co.	Los Angeles, Calif.
03705	Apex Machine & Tool Co.	Dayton, Ohio	10214	General Transistor Western Corp.	Los Angeles, Calif.	62119	Universal Electric Co.	Owosso, Mich.	76530	Monadnock Mills	San Leandro, Calif.
03797	Edema Corp.	El Monte, Calif.	10411	Ti-Tal, Inc.	Berkeley, Calif.	63743	Ward-Leonard Electric Co.	U. T. Vernon, N. Y.	76545	Mueller Electric Co.	Cleveland, Ohio
03877	Transitron Electronic Corp.	Wakefield, Mass.	10646	Carbonum Co.	Niagara Falls, N. Y.	64959	Western Electric Co., Inc.	New York, N. Y.	76854	Oak Manufacturing Co.	Crystal Lake, Ill.
03888	Pyrofilm Resistor Co.	Morristown, N. J.	11236	CTS of Berne, Inc.	Berne, Ind.	65092	Western Inst. Div. of Daystrom, Inc.	Newark, N. J.	77068	Bendix Pacific Division of	No. Hollywood, Calif.
03954	Air Marine Motors, Inc.	Los Angeles, Calif.	11237	Chicago Telephone of California, Inc.	So. Pasadena, Calif.	66295	Wilek Manufacturing Co.	Chicago 23, Ill.	77075	Phacof Metals Co.	San Francisco, Calif.
04009	Arrow, Hart and Hegeman Elect. Co.	Hartford, Conn.	11312	Microwave Electronics Corp.	Palo Alto, Calif.	66346	Wollensak Optical Co.	Rochester, N. Y.	77271	Pacific Instrument and Electronic Co.	South Pasadena, Calif.
04013	Taurus Corp.	Lambertville, N. J.	11534	Duncan Electronic, Inc.	Santa Ana, Calif.	70276	Allen Mfg. Co.	Hartford, Conn.	77250	Phoell Mfg. Co.	Chicago, Ill.
04062	Elenco Products Co.	New York, N. Y.	11711	General Instrument Corporation Semiconductor Division	Newark, N. J.	70309	Allmetal Screw Prod. Co., Inc.	Garden City, N. Y.	77252	Philadelphia Steel and Wire Corp.	Philadelphia, Pa.
04222	Hi-Q Division of Aerovox	Myrtle Beach, S. C.	11717	Imperial Electronic, Inc.	Buena Park, Calif.	70485	Atlantic India Rubber Works, Inc.	Chicago, Ill.	77342	Potter and Brumfield, Div. of American	Princeton, Ind.
04298	Eigen National Watch Co.,	Burbank, Calif.	11870	Metabs, Inc.	Palo Alto, Calif.	70563	Amperite Co., Inc.	New York, N. Y.	77630	Radio Condenser Co.	Camden, N. J.
04354	Precision Paper Tube Co.	Chicago, Ill.	12136	Philadelphia Handle Co.	Camden, N. J.	70930	Belden Mfg. Co.	Chicago, Ill.	77638	Radio Receptor Co., Inc.	Brooklyn, N. Y.
04404	Dymec Division of Hewlett-Packard Co.	Palo Alto, Calif.	12697	Claroat Mfg. Co.	Dover, N. H.	70998	Bird Electronic Corp.	Cleveland, Ohio	77764	Resistance Products Co.	Harrisburg, Pa.
04651	Sylvania Electric Prods., Inc.	Electronic Tube Div.	12859	Nippon Electric Co., Ltd.	Tokyo, Japan	71002	Birnbach Radio Co.	New York, N. Y.	77959	Rubbercraft Corp. of Calif.	Torrance, Calif.
04713	Motorola, Inc., Semiconductor Prod. Div.	Phoenix, Arizona	12930	Delta Semiconductor Inc.	Newport Beach, Calif.	71041	Boston Gear Works Div. of Murray Co. of Texas	Quincy, Mass.	78189	Shakeproof Division of Illinois	Elgin, Ill.
04732	Filtrol Co., Inc., Western Div.	Culver City, Calif.	13103	Thermolloy	Dallas, Texas	71218	Bud Radio Inc.	Cleveland, Ohio	78283	Signal Indicator Corp.	New York, N. Y.
04773	Automatic Electric Co.	Northlake, Ill.	13396	Telefunken (G. M. B. H.)	Hannover, Germany	71286	Camloc Fastener Corp.	Paramus, N. J.	78290	Stuthers-Dunn Inc.	Pittman, N. J.
04777	Automatic Electric Sales Corp.	Northlake, Ill.	13835	Midland Mfg. Co.	Kansas City, Kansas	71313	Allen D. Cardwell Electronic Prod. Corp.	Plainville, Conn.	78452	Thompson-Brener & Co.	Chicago, Ill.
04796	Sequoia Wire & Cable Co.	Redwood City, Calif.	14099	Sem-Tech	Newbury Park, Calif.	71400	Bussmann Fuse Div. of McGraw-Edison Co.	St. Louis, Mo.	78471	Tilley Mfg. Co.	San Francisco, Calif.
04811	Precision Coil Spring Co.	El Monte, Calif.	14193	Calif. Resistor Corp.	San Monica, Calif.	71436	Chicago Condenser Corp.	Chicago, Ill.	78474	Stackpole Carbon Co.	St. Marys, Pa.
04870	P. M. Motor Company	Chicago 44, Ill.	14298	American Components, Inc.	Conshohocken, Pa.	71450	CTS Corp.	Elkhart, Ind.	78493	Standard Thomson Corp.	Waltham, Mass.
05006	Twentieth Century Plastics, Inc.	Los Angeles, Calif.	14655	Cornell Dubilier Elec. Corp.	So. Plainfield, N. J.	71468	Cannon Electric Co.	Los Angeles, Calif.	78553	Tinnerman Products, Inc.	Cleveland, Ohio
05277	Westinghouse Electric Corp., Semi-Conductor Dept.	Youngwood, Pa.	14960	Williams Mfg. Co.	San Jose, Calif.	71471	Cinema Engineering Co.	Burbank, Calif.	78790	Transformer Engineers	Pasadena, Calif.
05347	Ultronic, Inc.	San Mateo, Calif.	15203	Webster Electronics Co. Inc.	Brooklyn, N. Y.	71482	C. P. Clare & Co.	Chicago, Ill.	78947	Ucnite Corp.	Newtonville, Mass.
05593	Illumitronic Engineering Co.	Sunnyvale, Calif.	15291	Adjustable Bushing Co.	N. Hollywood, Calif.	71590	Centralab Div. of Globe Union Inc.	Milwaukee, Wis.	79142	Vendo Root, Inc.	Hartford, Conn.
05616	Cosmo Plastic	Cleveland, Ohio	15772	Twentieth Century Coil Spring Co.	Santa Clara, Calif.	71616	Commercial Plastics Co.	Chicago, Ill.	79251	Wenco Mfg. Co.	Chicago, Ill.
05624	Barber Colman Co.	Rockford, Ill.	15909	The Daven Co.	Livingston, N. J.	71700	The Cornish Wire Co.	New York, N. Y.	79727	Continental-Wirt Electronics Corp.	Philadelphia, Pa.
05728	Tiffen Optical Co.	Roslyn Heights, Long Island, N. Y.	16037	Spruce Pine Mica Co.	Spruce Pine, N. C.	71744	Chicago Miniature Lamp Works	Chicago, Ill.	79963	Zierick Mfg. Corp.	New Rochelle, N. Y.
05729	Metropolitan Telecommunications Corp.,	Brooklyn, N. Y.	16352	Computer Diode Corp.	Lodi, N. J.	71753	A. O. Smith Corp., Crawley Div.	West Orange, N. J.	80031	Mecco Division of Sessions	Morristown, N. J.
05783	Stewart Engineering Co.	Santa Cruz, Calif.	16688	De Jur-Amsco Corporation	Long Island City 1, N. Y.	71785	Cinch Mfg. Corp.	Chicago, Ill.	80120	Schnitzer Alloy Products	Elizabeth, N. J.
05820	Wakefield Engineering Inc.	Wakefield, Mass.	16758	Delco Radio Div. of G. M. Corp.	Kokomo, Ind.	71984	Dow Corning Corp.	Midland, Mich.	80130	Times Facsimile Corp.	New York, N. Y.
06004	The Bassick Co.	Bridgport, Conn.	17109	Thermonetics Inc.	Canoga Park, Calif.	72092	Eitel-McCullough, Inc.	San Bruno, Calif.	80131	Electronic Industries Association.	Any brand tube meeting EIA standards
06175	Bausch and Lomb Optical Co.	Rochester, N. Y.	17474	Tranex Company	Mountain View, Calif.	72136	Electro Motive Mfg. Co., Inc.	Williamstown, Conn.	80207	Unimat Switch, Div. of	W. L. Maxson Corp.
06402	E. T. A. Products Co. of America	Chicago, Ill.	18486	Radio Industries	Des Plaines, Ill.	71707	Octo Coil Co., Inc.	Providence, R. I.	80223	United Transformer Corp.	Wallingford, Conn.
06475	Western Devices, Inc.	Inglewood, Calif.	18583	Curtis Instrument Inc.	Mt. Kisco, N. Y.	72354	John E. Fast & Co.	Brooklyn, N. Y.	80248	Oxford Electric Corp.	Chicago, Ill.
06540	Amatom Electronic Hardware Co. Inc.	New Rochelle, N. Y.	18873	E. I. DuPont and Co., Inc.	Wilmington, Del.	72619	Diagnal Corp.	Keasbey, N. J.	80294	Bourns Laboratories, Inc.	Riverside, Calif.
06555	Bede Electrical Instrument Co., Inc.	Peacock, N. H.	19315	Eclipse Pioneer, Div. of Bendix Aviation Corp.	Teterboro, N. J.	72656	General Ceramics Corp.	General Instrument Corp., Semiconductor Div.	80411	Acro Div. of Robertsshaw	Fulton Controls Co.
06751	U. S. Semicor Division of Nuclear Corp. of America	Phoenix, Arizona	19500	Thomas A. Edison Industries, Div. of McGraw-Edison Co.	West Orange, N. J.	72758	Girard-Hopkins	Newark, N. J.	80486	All Star Products Inc.	Columbus 16, Ohio
06812	Torrington Mfg. Co., West Div.	Van Nuys, Calif.	19701	Electra Manufacturing Co.	Kansas City, Mo.	72765	Drake Mfg. Co.	Chicago, Ill.	80509	Avery Adhesive Label Corp.	Defiance, Ohio
07088	Kelvin Electric Co.	Van Nuys, Calif.	20183	Electronic Tube Corp.	Philadelphia, Pa.	72825	Hugh H. Eby Inc.	Philadelphia, Pa.	80583	Hammerlund Co., Inc.	Monrovia, Calif.
			21226	Executive, Inc.	New York, N. Y.	72928	Gudeman Co.	Chicago, Ill.	80640	Stevens, Arnold, Co., Inc.	Boston, Mass.
			21520	Fanstle Metallurgical Corp.	No. Chicago, Ill.	72964	Robert M. Hadley Co.	Los Angeles, Calif.	81030	International Instruments, Inc.	New Haven, Conn.
			21335	The Falfur Bearing Co.	New Britain, Conn.	72982	Erie Resistor Corp.	Erie, Pa.	81073	Grayhill Co.	LaGrange, Ill.
			21964	Fed. Telephone and Radio Corp.	Clifton, N. J.	73061	Hansen Mfg. Co., Inc.	Princeton, Ind.	81095	Triad Transformer Corp.	Venice, Calif.
			24446	General Electric Co.	Schenectady, N. Y.	73076	H. M. Harper Co.	Chicago, Ill.	81312	Winchester Electronics Co., Inc.	Norwalk, Conn.
			24455	G. E., Lamp Division	Nela Park, Cleveland, Ohio	73138	Helipot Div. of Beckman Instruments, Inc.	Fullerton, Calif.			

Galley 3 - Hewlett Packard Code List

APPENDIX CODE LIST OF MANUFACTURERS (Sheet 2 of 2)

Code No.	Manufacturer	Address	Code No.	Manufacturer	Address	Code No.	Manufacturer	Address	Code No.	Manufacturer	Address
81349	Military Specification	85474	R.M. Bracamonte & Co.	San Francisco, Calif.	93929	G. V. Controls	Livingston, N. J.	98220	Francis L. Mosley	Pasadena, Calif.
81415	Wilkor Products, Inc.	Cleveland, Ohio	85660	Koiled Kords, Inc.	New Haven, Conn.	93983	Insuline-Van Norman Ind., Inc.	98278	Microdot, Inc.	So. Pasadena, Calif.
81453	Raytheon Mfg. Co., Industrial Components Div., Industr. Tube Operations	Newton, Mass.	85911	Seamless Rubber Co.	Chicago, Ill.	94137	Electronic Division	Manchester, N.H.	98291	Sealectro Corp.	Mamaroneck, N.Y.
81483	International Rectifier Corp.	El Segundo, Calif.	86197	Clifton Precision Products	Clifton Heights, Pa.	94144	General Cable Corp.	Bayonne, N.J.	98405	Carad Corp.	Redwood City, Calif.
81541	The Airpax Products Co.	Cambridge, Mass.	86579	Precision Rubber Products Corp.	Dayton, Ohio	94144	Raytheon Mfg. Co., Industrial Components Div., Receiving Tube Operation	Quincy, Mass.	98731	General Mills	Minneapolis, Minn.
81860	Barry Controls, Inc.	Watertown, Mass.	86684	Radio Corp. of America, RCA Electron Tube Div.	Harrison, N.J.	94145	Raytheon Mfg. Co., Semiconductor Div., California Street Plant	Newton, Mass.	98821	North Hills Electric Co.	Mineola, N.Y.
82042	Carler Parts Co.	Skokie, Ill.	87216	Philco Corporation (Lansdale Division)	Lansdale, Pa.	94148	Scientific Radio Products, Inc.	98925	Clevite Transistor Prod. Div. of Clevite Corp.	Waltham, Mass.
82142	Jefferis Electronics Division of Speer Carbon Co.	Du Bois, Pa.	87473	Western Fibrous Glass Products Co.	94154	Tung-Sol Electric, Inc.	Loveland, Colo.	98978	International Electronic Research Corp.	Burbank, Calif.
82170	Allen B. DuMont Labs, Inc.	Clifton, N.J.	87664	Van Waters & Rogers Inc.	Seattle, Wash.	94197	Curtiss-Wright Corp., Electronics Div.	Newark, N.J.	99109	Columbia Technical Corp.	New York, N.Y.
82209	Maguire Industries, Inc.	Greenwich, Conn.	87930	Tower Mfg. Corp.	Providence, R. I.	94222	Southco Div. of S. Chester Corp.	East Paterson, N.J.	99313	Varian Associates	Palo Alto, Calif.
82219	Sylvania Electric Prod. Inc., Electronic Tube Div.	Emporium, Pa.	88140	Cutter-Hammer, Inc.	Lincoln, Ill.	94310	Tro Ohm Prod. Div. of Modet Engineering and Mfg. Co.	Chicago, Ill.	99515	Marshall Industries, Electron Products Division	Pasadena, Calif.
82376	Astron Co.	East Newark, N.J.	88220	Goold-National Batteries, Inc.	St. Paul, Minn.	94330	Wire Cloth Products Inc.	Chicago, Ill.	99707	Control Switch Division, Controls Co. of America	El Segundo, Calif.
82389	Switchcraft, Inc.	Chicago, Ill.	88698	General Mills, Inc.	Buffalo, N.Y.	94682	Worcester Pressed Aluminum Corp.	Worcester, Mass.	99800	Delevan Electronics Corp.	East Aurora, N.Y.
82647	Metals and Controls, Inc., Div. of Spenser Prods.	Attleboro, Mass.	89231	Graybar Electric Co.	Oakland, Calif.	95023	Philbrick Researchers, Inc.	Boston, Mass.	99848	Wilco Corporation	Indianapolis, Ind.
82866	Research Products Corp.	Madison, Wis.	89462	Waldes Kohinor, Inc.	Cambridge, Mass.	95254	Lerco Electronics, Inc.	Burbank, Calif.	99934	Renbrandt, Inc.	Boston, Mass.
82877	Roton Manufacturing Co., Inc.	Woodstock, N.Y.	89473	General Electric Distributing Corp.	Schenectady, N.Y.	95265	National Coil Co.	Sheridan, Wyo.	99942	Hoffman Semiconductor Div. of Hoffman Electronics Corp.	Evanston, Ill.
82893	Vector Electronic Co.	Glendale, Calif.	89636	Carter Parts Div. of Economy Baler Co.	Chicago, Ill.	95236	Allies Products Corp.	Miami, Fla.	99957	Technology Instrument Corp	Newbury Park, Calif.
83053	Western Washer Mfr. Co.	Los Angeles, Calif.	89665	United Transformer Co.	Chicago, Ill.	95238	Continental Connector Corp.	Woodside, N.Y.			
83058	Carr Fastener Co.	Cambridge, Mass.	90179	U.S. Rubber Co., Mechanical Goods Div.	Passaic, N.J.	95263	Leecraft Mfg. Co., Inc.	New York, N.Y.			
83086	New Hampshire Ball Bearing, Inc.	Peterborough, N.H.	90970	Bearing Engineering Co.	San Francisco, Calif.	95264	Lerco Electronics, Inc.	Burbank, Calif.			
83125	Pyramid Electric Co.	Darlington, S.C.	91260	Connor Spring Mfg. Co.	San Francisco, Calif.	95265	National Coil Co.	Sheridan, Wyo.			
83148	Electro Cords Co.	Los Angeles, Calif.	91345	Miller Dial & Nameplate Co.	El Monte, Calif.	95275	Vitramon, Inc.	Bridgeport, Conn.			
83186	Victory Engineering Corp.	Springfield, N.J.	91418	Radio Materials Co.	Chicago, Ill.	95348	Gordas Corp.	Bloomfield, N.J.			
83298	Bendix Corp., Red Bank Div.	Red Bank, N.J.	91506	Augat Brothers', Inc.	Attleboro, Mass.	95354	Methode Mfg. Co.	Chicago, Ill.			
83315	Hubbell Corp.	Mundelein, Ill.	91637	Dale Electronics, Inc.	Columbus, Nebr.	95712	Dage Electric Co., Inc.	Franklin, Ind.			
83330	Smith, Herman H., Inc.	Brooklyn, N.Y.	91662	Elco Corp.	Philadelphia, Pa.	95987	Weckesser Co.	Chicago, Ill.			
83385	Central Screw Co.	Chicago, Ill.	91737	Grener Mfg. Co., Inc.	Warefield, Mass.	96067	Huggins Laboratories	Sunnyvale, Calif.			
83501	Gavitt Wire and Cable Co., Div. of Amerace Corp.	Brookfield, Mass.	91827	K F Development Co.	Redwood, Calif.	96095	Hi-Q Division of Aerovox	Olean, N.Y.			
83594	Burroughs Corp., Electronic Tube Div.	Plainfield, N.J.	91929	Minneapolis-Honeywell Regulator Co., Microswitch Div.	Freeport, Ill.	96256	Thordarson-Meissner Div. of Maguire Industries, Inc.	Mt. Carmel, Ill.			
83740	Eveready Battery	New York, N.Y.	91961	Nahm-Bros. Spring Co.	Oakland, Calif.	96296	Solar Manufacturing Co.	Los Angeles, Calif.			
83777	Model Eng. and Mfg., Inc.	Huntington, Ind.	92180	Tru-Connector Corp.	Peabody, Mass.	96330	Carlton Screw Co.	Chicago, Ill.			
83821	Loyd Scruggs Co.	Festus, Mo.	92196	Universal Metal Prod., Inc.	Bassett Puente, Calif.	96341	Microwave Associates, Inc.	Burlington, Mass.			
84171	Arco Electronics, Inc.	New York, N.Y.	92367	Elgett Optical Co., Inc.	Rochester, N.Y.	96501	Excel Transformer Co.	Oakland, Calif.			
84396	A.J. Glesener Co., Inc.	San Francisco, Calif.	92607	Tinsolite Insulated Wire Co.	Tarrytown, N.Y.	97464	Industrial Retaining Ring Co.	Irvine, N.J.			
84411	Good All Electric Mfg. Co.	Ogallala, Neb.	93332	Sylvania Electric Prod. Inc., Semiconductor Div.	Woburn, Mass.	97539	Automatic and Precision Mfg. Co.	Yonkers, N.Y.			
84970	Sarkes Tarzian, Inc.	Bloomington, Ind.	93369	Robbins and Myers, Inc.	Woburn, Mass.	97966	CBS Electronics, Div. of C.B.S., Inc.	Danvers, Mass.			
85454	Bonton Molding Company	Boonton, N.J.	93410	Stevens Mfg. Co., Inc.	Mansfield, N.J.	97979	Reon Resistor Corp.	Yonkers, N.Y.			
85471	A.B. Boyd Co.	San Francisco, Calif.	93788	Howard J. Smith Inc.	Port Monmouth, N.J.	98141	Axel Brothers Inc.	Jamaica, N.Y.			
						98159	Rubber Teck, Inc.	Gardena, Calif.			

THE FOLLOWING H-P VENDORS HAVE NO NUMBER ASSIGNED IN THE LATEST SUPPLEMENT TO THE FEDERAL SUPPLY CODE FOR MANUFACTURERS HANDBOOK.

J0000	Winchester Electronics, Inc.	Santa Monica, Calif.
0000F	Malco Tool and Die	Los Angeles, Calif.
0000M	Western Coil Div. of Automatic Ind., Inc.	Redwood City, Calif.
0000P	Ty-Car Mfg. Co., Inc.	Holliston, Mass.
0000Z	Willow Leather Products Corp.	Newark, N.J.
000AA	British Radio Electronics Ltd.	Washington, D.C.
000AB	ETA	England
000AC	Indiana General Corp., Elect. Div.	Indiana
000BB	Precision Instrument Components Co.	Van Nuys, Calif.
000MM	Rubber Eng. & Development	Hayward, Calif.
000NN	A "N" D Manufacturing Co.	San Jose 27, Calif.
000QQ	Cooltron	Oakland, Calif.
000SS	Control of Elgin Watch Co.	Burbank, Calif.
000YY	California Eastern Lab.	Burlingame, Calif.
	S.K. Smith Co.	Los Angeles 45, Calif.



ELECTRONIC INSTRUMENTATION SALES AND SERVICE UNITED STATES, CANADA, CENTRAL AND SOUTH AMERICA

UNITED STATES

ALABAMA

P.O. Box 4207
2003 Byrd Spring Road S.W.
Huntsville 35802
TWX: 510-579-2204
Tel: (205) 881-4591

ARIZONA

3009 North Scottsdale Road
Scottsdale 85251
Tel: (602) 945-7601
TWX: 910-950-1282

232 South Tucson Boulevard
Tucson 85716

Tel: (602) 623-2564
TWX: 910-952-1162

CALIFORNIA

3939 Lankershim Boulevard
North Hollywood 91604
Tel: (213) 877-1282
TWX: 910-499-2170

1101 Embarcadero Road
Palo Alto 94303
Tel: (415) 327-6500
TWX: 910-373-1280

2591 Carlsbad Avenue
Sacramento 95821
Tel: (916) 482-1463
TWX: 910-367-2092

1055 Shafter Street
San Diego 92106
Tel: (714) 223-8103
TWX: 910-335-2000

COLORADO

7965 East Prentice
Englewood 80110
Tel: (303) 771-3455
TWX: 910-935-0705

CONNECTICUT

508 Tolland Street
East Hartford 06108
Tel: (203) 289-9394
TWX: 910-425-3416

111 East Avenue
Norwalk 06851
Tel: (203) 853-1251
TWX: 710-468-3750

DELAWARE

3941 Kennett Pike
Wilmington 19807
Tel: (302) 655-6161
TWX: 510-666-2214

FLORIDA

Suite 106
9999 N.E. 2nd Avenue
Miami Shores 33138
Tel: (305) 758-3626
TWX: 810-848-7262

P.O. Box 20007
Herndon Station 32814
621 Commonwealth Avenue
Orlando
Tel: (305) 841-3970
TWX: 810-850-0113

P.O. Box 8128
Madeira Beach 33708
410 150th Avenue
St. Petersburg
Tel: (813) 391-0211
TWX: 810-863-0366

GEORGIA

3110 Maple Drive N.E.
Atlanta 30305
Tel: (404) 233-1141
TWX: 810-751-3283

ILLINOIS

5500 Howard Street
Skokie 60076
Tel: (312) 677-0400
TWX: 910-223-3613

INDIANA

4002 Meadows Drive
Indianapolis 46205
Tel: (317) 546-4891
TWX: 810-341-3263

LOUISIANA

P.O. Box 856
1942 Williams Boulevard
Kenner 70062
Tel: (504) 721-6201
TWX: 810-955-5524

MARYLAND

6707 Whitestone Road
Baltimore 21207
Tel: (301) 944-5400
TWX: 710-862-0850

P.O. Box 727
Twinbrook Station 20851
12303 Twinbrook Parkway
Rockville
Tel: (301) 427-7560
TWX: 710-828-9684

MASSACHUSETTS

Middlesex Turnpike
Burlington 01803
Tel: (617) 272-9000
TWX: 710-332-0382

MICHIGAN

24315 Northwestern Highway
Southfield 48076
Tel: (313) 353-9100
TWX: 810-232-1532

MINNESOTA

2459 University Avenue
St. Paul 55114
Tel: (612) 646-7881
TWX: 910-563-3734

MISSOURI

9208 Wyoming Place
Kansas City 64114
Tel: (816) 333-2445
TWX: 910-771-2087

2812 South Brentwood Blvd.
St. Louis 63144
Tel: (314) 644-0220
TWX: 910-760-1670

NEW JERSEY

Crystal Brook Prof. Bldg.
Route 35
Eatontown
Tel: (201) 747-1060
391 Grand Avenue
Englewood 07631
Tel: (201) 567-3933
TWX: 710-991-9707

NEW MEXICO

P.O. Box 8366
Station C 87108
6501 Lomas Boulevard N.E.
Albuquerque
Tel: (505) 255-5586
TWX: 910-989-1665
156 Wyatt Drive
Las Cruces 88001
Tel: (505) 526-2486
TWX: 910-983-0550

NEW YORK

1219 Campville Road
Endicott 13760
Tel: (607) 754-0050
TWX: 510-252-0890

236 East 75th Street
New York 10021
Tel: (212) 879-2023
TWX: 710-581-4376

82 Washington Street
Poughkeepsie 12601
Tel: (914) 454-7330
TWX: 510-248-0012

39 Saginaw Drive
Rochester 14623
Tel: (716) 473-9500
TWX: 510-253-5981

1025 Northern Boulevard
Roslyn, Long Island 11576
Tel: (516) 869-8400
TWX: 510-223-0811

5858 East Molloy Road
Syracuse 13211
Tel: (315) 454-2486
TWX: 710-541-0482

NORTH CAROLINA

P.O. Box 5187
Salt Lake City 84115
Tel: (801) 486-8166
TWX: 910-925-5681

OHIO

5579 Pearl Road
Cleveland 44129
Tel: (216) 884-9209
TWX: 810-421-8500

1250 West Dorothy Lane
Dayton 45409
Tel: (513) 298-0351
TWX: 810-459-1925

OREGON

2737 S.W. Corbett Avenue
Portland 97201
Tel: (503) 228-5107

PENNSYLVANIA

Park Place Office Building
Camp Hill
Tel: (717) 737-6791

Monroe Complex
Moss Side Boulevard
Monroeville 15146
Tel: (412) 271-0724
TWX: 710-797-3650
144 Elizabeth Street
West Conshohocken 19428
Tel: (215) 248-1600, 828-6200
TWX: 510-660-8715

TEXAS

P.O. Box 7166
3605 Inwood Road
Dallas 75209
Tel: (214) 357-1881
TWX: 910-861-4081

P.O. Box 22813
4202 Richmond Avenue
Houston 77027
Tel: (713) 667-2407
TWX: 910-881-2645

GOVERNMENT CONTRACT OFFICE
225 Billy Mitchell Road
San Antonio 78226
Tel: (512) 434-4171
TWX: 910-871-1170

UTAH

2890 South Main Street
Salt Lake City 84115
Tel: (801) 486-8166
TWX: 910-925-5681

VIRGINIA

P.O. Box 6514
2111 Spencer Road
Richmond 23230
Tel: (703) 282-5451
TWX: 710-956-0157

WASHINGTON

11656 N.E. Eighth Street
Bellevue 98004
Tel: (206) 454-3971
TWX: 910-443-2303

FOR AREAS NOT LISTED, CONTACT:

Hewlett-Packard
1501 Page Mill Road
Palo Alto, California 94304
Tel: (415) 326-7000
TWX: 910-373-1267
Telex: 34-8461

CANADA

BRITISH COLUMBIA

Hewlett-Packard (Canada) Ltd.
2184 West Broadway
Vancouver
Tel: (604) 738-7520
TWX: 610-922-5050

ONTARIO

Hewlett-Packard (Canada) Ltd.
880 Lady Ellen Place
Ottawa 3
Tel: (613) 722-4223
TWX: 610-562-1952

Hewlett-Packard (Canada) Ltd.

1415 Lawrence Avenue West
Toronto
Tel: (416) 249-9196
TWX: 610-492-2382

QUEBEC

Hewlett-Packard (Canada) Ltd.
275 Hymus Boulevard
Pointe Claire
Tel: (514) 697-4232
TWX: 610-422-3022
Telex: 01-2819

FOR AREAS NOT LISTED, CONTACT:

Hewlett-Packard Inter-Americas
1501 Page Mill Road
Palo Alto, California 94304
Tel: (415) 326-7000
TWX: 910-373-1267
Telex: 034-8461
Cable: HEWPACK Palo Alto

CENTRAL AND SOUTH AMERICA

ARGENTINA

Mauricio A. Suárez
Telecomunicaciones
Carlos Calvo 224
Buenos Aires
Tel: 30-6312, 34-9087

BRAZIL

Ciental, Importação e
Comércio Ltda.
Rua Cleto Campelo, 44 - 5º andar
Recife

Ciental, Importação e
Comércio Ltda.
Avenida 13 de Maio, 13-22º andar
Rio de Janeiro, G.B.

Ciental, Importação e
Comércio Ltda.
Rua Des. Eliseu Guilherme, 62
São Paulo 8
Tel: 70-2318

CHILE

Héctor Calcagni
Casilla 13942
Santiago
Tel: 490.505, 393.119

COSTA RICA

Lic. Alfredo Gallegos Gurdíán
Apartado 3243
San José
Tel: 21-86-13

EL SALVADOR

Electrónica
Apartado Postal 1589
San Salvador
Tel: 4683

GUATEMALA

Olander Associates Latin America
Apartado 1226
7a. Calle, 0-22, Zona 1
Guatemala City
Tel: 22812

MEXICO

Hewlett-Packard Mexicana,
S.A. de C.V.
Eugenia 408, Dept. 1
Mexico 12, D.F.

NICARAGUA

Roberto Terán G.
Edificio Terán
Apartado Postal 689
Managua
Tel: 3451, 3452

PANAMA

Electrónico Balboa, S.A.
P.O. Box 4929
Panama City
Tel: 3-0833

PERU

Fernando Ezeta B.
Av. Petit Thouars 4719
Casilla 3061
Lima
Tel: 50346

PUERTO RICO

San Juan Electronics, Inc.
Ponce de León No. 150, Stop 3
Pta. de Tierra Sta.
San Juan
Tel: (809) 725-3342

VENEZUELA

Citec, C.A.
Edif. Arisan-Of. #4
Avda. Francisco de Miranda
Apartado del Este 10934 Chacaito
Caracas
Tel: 71.88.05

FOR AREAS NOT LISTED, CONTACT:

Hewlett-Packard Inter-Americas
1501 Page Mill Road
Palo Alto, California 94304
Tel: (415) 326-7000
TWX: 910-373-1267
Telex: 034-8461
Cable: HEWPACK Palo Alto



ELECTRONIC INSTRUMENTATION SALES AND SERVICE

EUROPE, AFRICA, ASIA, AUSTRALIA

EUROPE

AUSTRIA

Unilabor HmbH
Wissenschaftliche Instrumente
Rummelhardtgasse 6/3
P.O. Box 33
Vienna IX/71
Tel: 426 181

BELGIUM

Hewlett-Packard Benelux S.A.
20-24 rue de l'Hôpital
Brussels
Tel: 11 22 20

DENMARK

Tage Olsen A/S
Rønnegade 1
Copenhagen Ø
Tel: 29 48 00

FINLAND

INTO O/Y
Merittullinkatu 11
P.O. Box 10153
Helsinki 10
Tel: 61 133

FRANCE

Hewlett-Packard France
2, rue Tête d'Or
Lyon, 6 - Rhône
Tel: 52 35 66
Hewlett-Packard France
150 Boulevard Massena
Paris 13e
Tel: 707 97 19

GERMANY

Hewlett-Packard Vertriebs-GmbH
Lietzenburger Strasse 30
1 Berlin W 30
Tel: 24 86 36

Hewlett-Packard Vertriebs-GmbH
Herrenberger Strasse 110
703 Böblingen, Württemberg
Tel: 6971

Hewlett-Packard Vertriebs-GmbH
Achenbachstrasse 15
4 Düsseldorf 1
Tel: 68 52 58

Hewlett-Packard Vertriebs-GmbH
Kuhhessenstrasse 95
6 Frankfurt 50
Tel: 52 00 36

Hewlett-Packard Vertriebs-GmbH
Beim Strohhause 26
2 Hamburg 1
Tel: 24 05 52

Hewlett-Packard Vertriebs-GmbH
Reginfriedstrasse 13
8 Munich 9
Tel: 49 51 21

GREECE

Kostos Karayannis
18, Ermou Street
Athens 126
Tel: 230 301

IRELAND

Hewlett-Packard Ltd.
224 Bath Road
Slough, Bucks, England
Tel: Slough 28406-9, 29486-9

ITALY

Hewlett-Packard Italiana S.p.A.
Viale Lunigiana 46
Milan
Tel: 69 15 84

Hewlett-Packard Italiana S.p.A.
Palazzo Italia
Piazza Marconi 25
Rome - Eur
Tel: 591 2544

NETHERLANDS

Hewlett-Packard Benelux, N.V.
de Boelelaan 1043
Amsterdam, Z.2
Tel: 42 77 77

NORWAY

Morgenstjerne & Co. A/S
Ingeniørfirma
6 Wessels Gate
Oslo
Tel: 20 16 35

PORTUGAL

Telectra
Rua Rodrigo da Fonseca 103
P.O. Box 2531
Lisbon 1
Tel: 68 60 72

SPAIN

Ataio Ingerieros
Urgel, 259
Barcelona, 11
Tel: 230-69-88
Ataio Ingenieros
Enrique Larreta 12
Madrid, 16
Tel: 235 43 44

SWEDEN

HP Instrument AB
Hagakergatan 7
Möndal
Tel: 031 - 27 68 00
HP Instrument AB
Centralvägen 28
Solna
Tel: 08 - 83 08 30

SWITZERLAND

HEWPAK AG
Zuricherstrasse 20
8952 Schlieren
Zurich
Tel: (051) 98 18 21

TURKEY

Telekom Engineering Bureau
P.O. Box 376 - Galata
Istanbul
Tel: 49 40 40

UNITED KINGDOM

Hewlett-Packard Ltd.
224 Bath Road
Slough, Bucks
Tel: Slough 28406-9, 29486-9

YUGOSLAVIA

Belram S.A.
83 avenue des Mimosas
Brussels 15, Belgium
Tel: 35 29 58

FOR AREAS NOT LISTED, CONTACT:

Hewlett-Packard S.A.
54 Route des Acacias
Geneva, Switzerland
Tel: (022) 42 81 50
Telex: 2.24.86
Cable: HEWPACKSA Geneva

AFRICA, ASIA, AUSTRALIA

AUSTRALIA

Sample Electronics (Vic) Pty., Ltd.
22-26 Weir Street
Glen Iris S.E. 6
Melbourne, Victoria
Tel: 20-1371 (4 lines)
Sample Electronics
(N.S.W.) Pty. Ltd.
4 Grose Street
Glebe, New South Wales
Tel: 69-6338

ETHIOPIA

African Salespower & Agency
Private Ltd., Co.
P. O. Box 718
Addis Ababa
Tel: 44090

INDIA

The Scientific Instrument Co., Ltd
6, Tej Bahadur Sapru Road
Allahabad 1
Tel: 2451
The Scientific Instrument Co., Ltd
240, Dr. Dadabhai Naoroji Road
Bombay 1
Tel: 26-2642

The Scientific Instr. Co., Ltd.
11, Esplanade East
Calcutta 1
Tel: 23-4129

The Scientific Instrument Co., Ltd.
30, Mount Road
Madras 2
Tel: 86339

The Scientific Instrument Co., Ltd.
B-7, Ajmeri Gate Extn.
New Delhi 1
Tel: 27-1053

IRAN

Telecom, Ltd.
P. O. Box 1812
Teheran
Tel: 43850, 48111

ISRAEL

Electronics & Engineering
Division of Motorola Israel Ltd.
16, Kremenetski Street
Tel-Aviv
Tel: 35021/2/3

JAPAN

Yokogawa-Hewlett-Packard Ltd.
Shinbanyu Building
No. 8, Umeda
Kita-ku, Osaka City
Tel: 313-0091

Yokogawa-Hewlett-Packard Ltd.
Ito Building
No. 59, Kotori-cho
Nakamura-ku, Nagoya City
Tel: 551-0215

Yokogawa-Hewlett-Packard Ltd.
Ohashi Building
No. 59, I-chome, Yoyogi
Shibuya-ku, Tokyo
Tel: 370-2281

KENYA

R. J. Tilbury Ltd.
P. O. Box 2754
Suite 517/518
Hotel Ambassadeur
Nairobi
Tel: 25670, 26803, 68206

KOREA

American Trading Co., Korea, Ltd.
Seoul P. O. Box 1103
112-35 Sokong-Dong
Jung-ku, Seoul
Tel: 3.7049, 3.7613

LEBANON

Constantin E. Macridis
Clemenceau Street
Clemenceau Center
Beirut
Tel: 220846

NEW ZEALAND

Sample Electronics (N.Z.) Ltd.
8 Matipo Street
Onehunga S.E. 5
Auckland
Tel: 667-356

PAKISTAN (EAST)

Mushko & Company, Ltd.
Zirat Chambers
31, Jinnah Avenue
Dacca
Tel: 80058

PAKISTAN (WEST)

Mushko & Company, Ltd.
Oosman Chambers
Victoria Road
Karachi 3
Tel: 51027, 52927

SOUTH AFRICA

F. H. Flanter & Co. (Pty.), Ltd.
Rosella House
Buitencingle Street
Cape Town
Tel: 3-3817

F. H. Flanter & Co. (Pty.), Ltd.
104 Pharmacy House
80 Jorissen Street
Braamfontein, Johannesburg
Tel: 724-4172

TAIWAN

Hwa Sheng Electronic Co., Ltd.
P. O. Box 1558
21 Nanking West Road
Taipei
Tel: 46076, 45936

THAILAND

The International
Engineering Co., Ltd.
P. O. Box 39
614 Sukhumvit Road
Bangkok
Tel: 913460-1-2

FOR AREAS NOT LISTED, CONTACT:

Hewlett-Packard Export Marketing
1501 Page Mill Road
Palo Alto, California 94304
Tel: (415) 326-7000
Telex: 034-8461
Cable: HEWPACK Palo Alto

MANUAL BACKDATING CHANGES

MODEL 241A

PUSHBUTTON OSCILLATOR

Manual Serial Prefixed: 324
-hp- Part No: 241A-904

To adapt this manual to instruments with other serial prefixes check for errata below, and make changes shown in tables.





NOTE

This manual backdating sheet makes this manual applicable to earlier instruments. Instrument-component values that differ from those in the manual, yet are not listed in the backdating sheet, should be replaced using the stock number given in the manual.

Instrument Serial Prefix	Make Manual Changes	Instrument Serial Prefix	Make Manual Changes
303-00100 and below	1		

CHANGE #1

Figure 5-11 and Table of Replaceable Parts,

- C4: Change to Capacitor, fixed, 47 pf $\pm 5\%$; Mfr. No. 04062;  Stock No. 0140-0039.
- R7: Change to Resistor, fixed, 8200 ohms $\pm 10\%$, 1/4 W; Mfr. No. 01121;  Stock No. 0684-8221; *Average value given, optimum value selected at factory.
- R179: Change to Resistor, fixed, 10 ohms $\pm 10\%$, 1/2 W; Mfr. No. 01121;  Stock No. 0687-1001.
- R180: Change to Resistor, fixed, 27 ohms $\pm 10\%$, 1/2 W; Mfr. No. 01121;  Stock No. 0687-2701.

MANUAL CHANGES

MODEL 241A

OSCILLATOR

Manual Serial Prefix: 324

-hp- Part No. 241A-904

New or revised item

Instrument Serial Number	Make Manual Changes	Instrument Serial Number	Make Manual Changes
324-02350 and above	CHANGE #1		
324-02450 and above	CHANGE #2		

CHANGE #1

Page 5-11/5-12, Figure 5-10:

Change R6 from 560 ohms to 390 ohms.

Page 6-4, Table 6-1:

Change R6 from 560 ohms, 0684-5611 to 390 ohms, 0684-3911.

CHANGE #2

Page 5-15/5-16, Figure 5-12:

Connect a 5 pF capacitor in parallel with R119.
Designate this capacitor C141.

Connect a 5 pF capacitor in parallel with R120.
Designate this capacitor C142.

Connect a 5 pF capacitor in parallel with R121.
Designate this capacitor C143.

Add these capacitors (Part No. 0160-0763) to Table 6-1.
These capacitors are all factory selected values.

NOTES

